

Technical Catalogue HERA

R290



Air-to-Water reversible Heat Pump for outdoor installation

Nominal Heating Capacity: 29-174kW | 50Hz



EUROKLIMAT
Cooling System Solutions

HERA Solutions

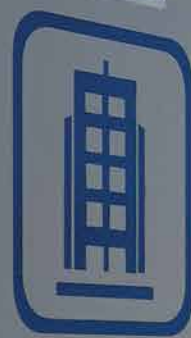

HERA



Market demands



Euroklimat's responses

Long term refrigerant

R290 Natural gas

Energy efficiency

Inverter driven technology

Easy to install

Plug&Play system and Master-Slave logic

Index

HERA The Natural reversible heat pump		4
Natural refrigerant Propane & flammability		6
Safety		7
Maximum allowable R290 charge		8
HERA Applications		9
HERA Advantages		10
HERA product range		12
Operating limits		13
R290 reciprocating compressor with INVERTER		14
Intelligent Defrosting System		15
HERA Modular solution Master & Slave(S)		16
Advanced Electronic Controller		18
Remote monitoring services tERA		19
Refrigerant Circuit Diagram		20
How to select		21
HERA Technical data	035-1-1 PE ↔ 095-1-1 PE	22
HERA Technical data	110-2-2 PE ↔ 190-2-2 PE	24
Performance tables by model Heating		26
Performance tables by model Cooling		29
Customizable and Accessories		32
HERA Plug & Play solution Hydronic Kit		38
Acoustic configurations		40
Sound levels		41
Applications in extreme climate conditions (down to -20°C)		42
Dimensions and Operating spaces		44
How it is made		46
Transport of the unit with R290 charge		48
Standard and optional packing		49
WebService2		50
R290 References		52
Some R290 Installations		53
Our plants and quality management		55

HERA



ANTI-UV ELECTRICAL CABLE

The electric cables of the fans, which are positioned outside, have a special sheath that protects them from ultraviolet radiation and can withstand even at low temperatures.



EC FANS

High efficiency EC fans, electronically commutated, useful to reduce energy power consumption.



ELECTRICAL BOARD

Switchboard made according to standards IEC 204-1/EN60204-1, complete with main isolator switch, door interlock safety device. Protection index: IP54.



ADVANCED CONTROL

The most advanced technology available, with proprietary optimized software specifically designed for this application.



COMPRESSOR WITH INVERTER

Inverter driven compressor, that allows to significantly increase the efficiency of the unit at partial loads and to reduce electrical power consumption.



The Natural reversible heat pump



SAFETY VALVE



The safety valve is conveyed outside the unit and a special kit is supplied for the final part of the conveying pipe.

GAS DETECTOR



ATEX certified gas detector installed inside the compressor's box, ensures the activation of the adequate safety measures in case of R290 leakage.

SOLID AND LIGHT STRUCTURE



Structure specifically designed and built to guarantee total resistance to atmospheric agents and corrosion. Base and panels made of galvanized steel sheet, oven-painted with polyurethane powders. Equipped with special openings that facilitate the handling of the unit and allow a simple and quick installation.

ATEX FAN



Ex-rated centrifugal fan, which ensures emergency ventilation inside the compressor's box in case of R290 leakage.

Natural refrigerant Propane & flammability

Interest and application of hydrocarbon (HC) refrigerants is growing, especially now that the global warming impact of refrigerants is becoming an increasingly important aspect for the refrigeration and air conditioning industry.

It is widely known that HCs are excellent refrigerants in terms of performance and because of their negligible environmental impact aspects. However, it is generally acknowledged that their main hindrance is related to their flammability.

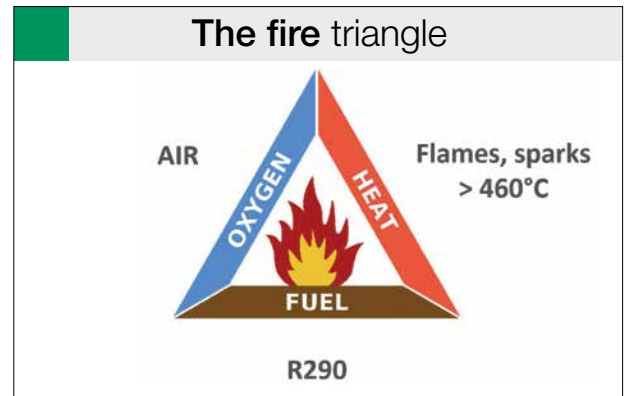

If you control these components, fire can be avoided.

To achieve this, Euroklimat has considered three general guidelines:

Containment of the substance (propane – R290)



- HERA's refrigerant circuit is leak-tight, and it sufficiently robust throughout its lifetime.
- Pipework is designed to have few pipe joints.
- **All the materials are fully compatible with the HC refrigerant.**

Avoidance of ignition sources



- Some components are **ATEX certified**.
- Electrical panel is fitted in a **separate compartment**.
- Cable glands are at least IP65 and we have a **double-barrier**.

Use of leak detector & ventilation system



- Every unit is equipped with a stand-alone **gas detection system**.
- The sensor is **ATEX Certified** and is pre-calibrated at the factory.
- The fan is ATEX Certified and it is **automatically activated** in case of unlikely leak of propane.

Protection of workers that may come into contact with flammable atmospheres in the workplace.

This may be achieved through leak-tight design, ventilation and certain protective systems.

Where it is possible for a flammable atmosphere to be created, those responsible for the positioning or installation of the equipment must ensure that ignition of that flammable atmosphere is not possible, for example, through elimination of potential sources of ignition.

Euroklimat Approach



- Basic safety with flammable refrigerants
- Safe design for HC refrigerants

- To ensure that a detailed safety evaluation has been carried out
- To Enable the identification of ways and means to improve the level of safety of the systems and equipment, by way of detailed investigations of all of the factors that affect the risk







- To ensure the customer a certification path
- Run the validation process of the project pre-market



Maximum allowable R290 charge

Maximum allowable charge of Refrigerating systems and heat pumps should be evaluated according to **EN378:2016**. EN378:2016 is a safety and environmental standard published by CEN that provides guidance for Design, Construction, Installation, Operation and Maintenance of Refrigerating systems and heat pumps.

Maximum allowable charge depends on:	HERA HEAT PUMPS	
	Gas Classification	A3 (High Flammability, Low Toxicity)
	Application Type	Human Comfort
	Equipment Location	Open air
	Installation Characteristics 1	Other
	Installation Characteristics 2	Above ground
	Installation type	Floor location
	Device type	Fixed system
	Access Category	General, Supervised, Authorized

Access Category		Max. allowable R290 charge		HERA
	General		5 Kg	HERA 35-1-1 PE
	Supervised		10 Kg	HERA 35-1-1 PE HERA 55-1-1 PE HERA 65-1-1 PE HERA 80-1-1 PE HERA 95-1-1 PE HERA 110-2-2 PE HERA 130-2-2 PE
	Authorized		NO LIMITS	All models

HERA Applications

Offices

Installation is quite easy.
Heat pumps are clean, quiet and odourless. They are powered by electricity and they require minimal regular maintenance.



Shopping Centres

The basic main advantages are the efficiency of converting energy to heat and the ability to provide heating and cooling at the same time, using the DS (Desuperheater) option.



Industries

Dairy, Pharmaceutical, Textile, Food Processing, Winery. Heat pumps keep energy costs as low as possible which is the most important thing for any industry.



Hospitals

Safety and low risk of accidents, considering the danger of conventional heating systems particularly when they are outdated.



Residential

HERA heat pumps are free from contaminants which may cause harm to the environment. It'll help to load off the work of boiler which produces carbon monoxide when faulty, which is harmful to health.



HERA Advantages

The HERA air-cooled reversible heat pumps offer you optimised natural solutions combining 5 major advantages in a compact package.

Innovation

The new HERA reversible heat pumps are designed to withstand even the most severe winter conditions since they are designed and tested to work down to **-20°C ambient temperature**.

Innovative and customized software that allows to manage dynamically and efficiently **defrost** cycles. A special algorithm developed by the Euroklimat technical team simulates an **artificial intelligence** that allows to better exploit the machine's performance and to minimize energy waste during defrost phases.

Winner of **Innodriver** European call for innovation.



Efficiency

Extremely **high-efficiency** inverter compressor technology. Inverter compressor technology offers new opportunities for air conditioning systems, first of all in terms of energy efficient buildings, reduced energy

consumption and lower running costs.

Continuous adaptation to heating or cooling demand provides higher energy savings and accurate temperature control.

Eco-Design Ready.

The EU Ecodesign Directive adopted in 2009 provides rules for improving the environmental performance of products by setting out minimum energy efficiency mandatory requirements for specific product groups.

Hera heat pumps comply with the Regulation (EU) No 813/2013, 811/2013 (for models where applicable).

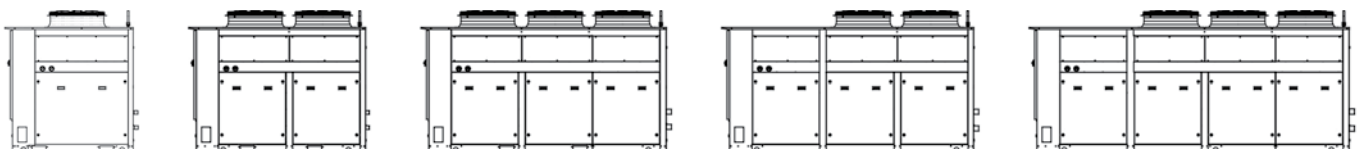
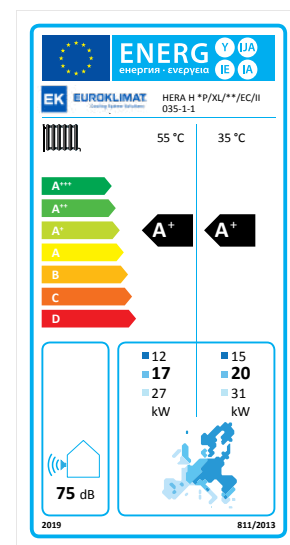

HERA Advantages

Green technology

R290 (Propane): Natural and efficient refrigerant suitable for heat pumps applications. Due to the concern for the effects of the release of HFC refrigerants on the global environment caused by the high global warming potential of these substances, there is a large interest in Europe and elsewhere for the use of hydrocarbons as refrigerants.

R290: the long-term solution.
Very Low GWP (**GWP R290 = 3**) suitable to be used up to 2030 without any restriction connected to F-Gas Regulation.



High safety

HERA heat pumps are charged with R290 (propane) that is a non-toxic flammable refrigerant.

To ensure the maximum level of safety, an **Ex-rated Gas detector** is installed as a standard.

Ex-rated extractor fan, able to achieve adequate level of ventilation in case of a unlikely R290 leakage.

Use of ATEX certified components where necessary and the **separate compartment of the electrical panel**, they guarantee very high safety levels.



Plug&Play

HERA heat pumps range provides an all-in-one solution thanks to the integrated hydraulic module (optional) which contains all the water circuit components needed for the system to operate correctly. A wide selection of hydraulic couplings to fit site configuration:

- **Single or twin pump(s) with automatic switchover**
- **Standard or high pressure pump(s)**
- **Fixed or variable speed allowing for automatic adjustment of water flow according to water loop requirements**
- **Fixed or variable flow for increased energy savings**

The optimized foot-print reduce the use of the surface area for easy integration into an existing building.

Quick, easy and cost-effective installation and commissioning.



HERA Solutions

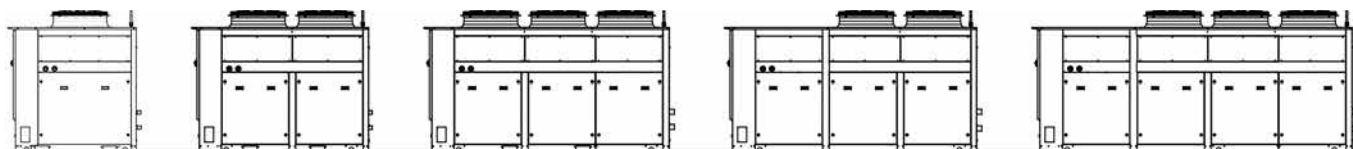

Heating Capacity ⁽¹⁾

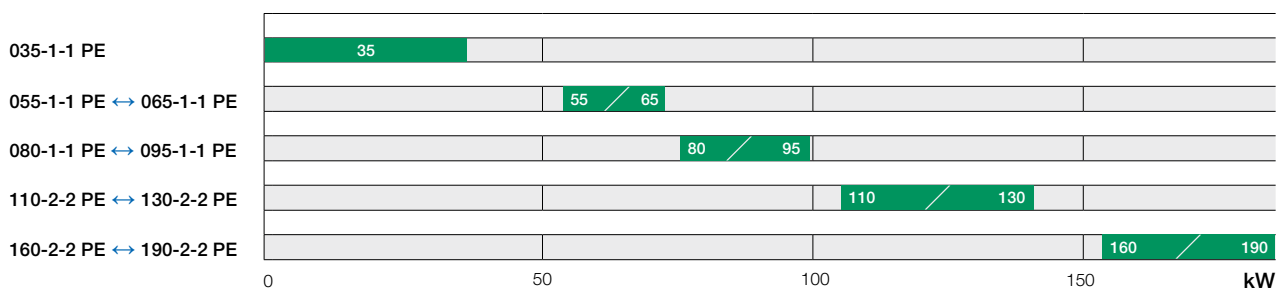

Reference conditions:

⁽¹⁾ Ambient: +7°C / 87% r.h.
 Condenser water temperature IN/OUT = 40/45°C
 Fluid: water

1.100+ kW with Modular solution | Master & Slave(S)

See page 16 for more details.

	N. of refrigerant circuits	Compressors Quantity	Fans quantity	Exchanger type
035-1-1 PE	1			
055-1-1 PE ↔ 065-1-1 PE	1			
080-1-1 PE ↔ 095-1-1 PE	1			
110-2-2 PE ↔ 130-2-2 PE	2			
160-2-2 PE ↔ 190-2-2 PE	2			

Icons legend



Refrigerant
R290 | GWP=3



Semi-hermetic
piston compressor



Axial fan



Brazen plate
heat exchanger

Operating limits

HERA

Number of models: **9** - Number of possible configurations: **1000+**

OPERATING LIMITS - HEATING

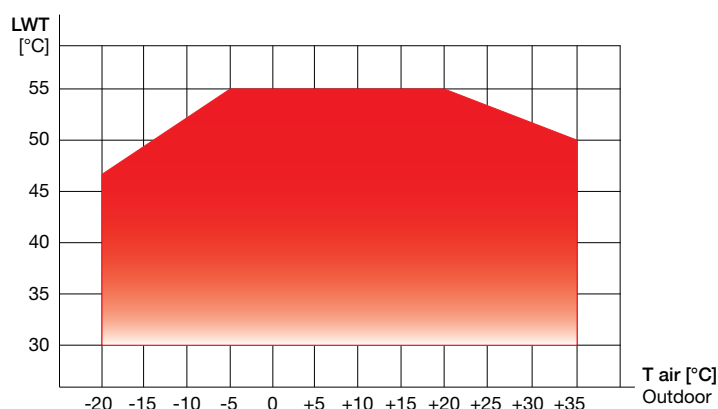

Standard operating area
[dT condenser water side: min. 3 max. 7K]

T air: Outdoor air temperature [°C] (DB)
LWT: Condenser outlet temperature [°C]

DESUPERHEATER OPERATING LIMITS

Heating mode

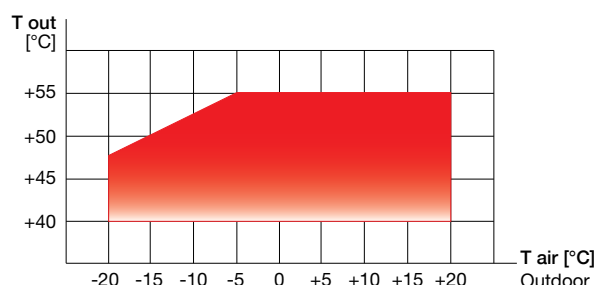

Operating area with Desuperheater

T out: Desuperheater exchanger outlet water temperature [°C]
T air: Outdoor air temperature [°C] (DB)
Inlet desuperheater temperature > 35°C

OPERATING LIMITS - COOLING

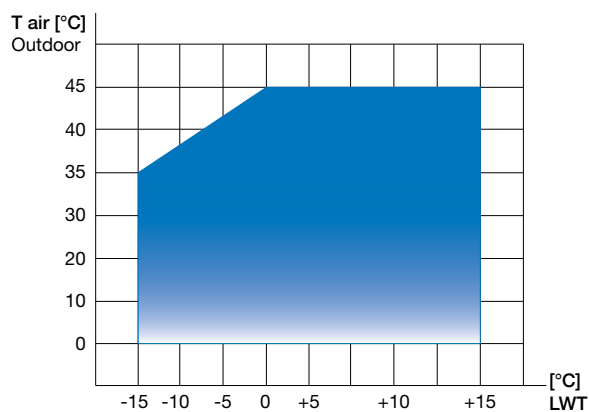

Standard operating area
[dT evaporator water side: min. 3 max. 7K]

T air: Outdoor air temperature [°C] (DB)
LWT: Condenser outlet temperature [°C]

└─ Meg 50% ─┘ └─ Meg 40% ─┘ └─ Meg 30% ─┘ └─ Meg 20% ─┘ └─ Water ─┘

DESUPERHEATER OPERATING LIMITS

Cooling mode

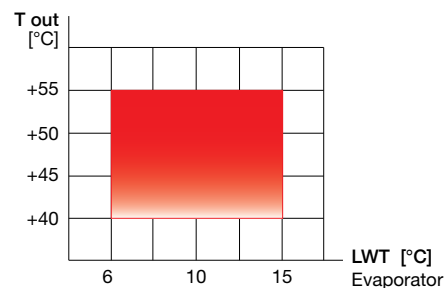

Operating area with Desuperheater

T out: Desuperheater exchanger outlet water temperature [°C]
LWT: Evaporator outlet temperature [°C]
Inlet desuperheater temperature > 35°C

R290 reciprocating compressor with inverter

Advantages

When comparing with alternative control systems and technologies, a frequency converter is the optimum energy control system for controlling compressors.

- » Improved system quality by maintaining a constant leaving water temperature
- » Wider range of operation of the heating or cooling power
- » Increased power by increasing the speed of the variable speed compressor
- » Energy saving
- » Longer compressor lifetime
- » Better possibilities of providing monitoring, remote setting and diagnostics



Energy consumption minimized and maximizing comfort levels thanks to HERA's INVERTER

Exact capacity match

Thanks to the advanced P.I.D. control, a last-generation inverter frequency control system and electronic expansion valve management algorithm, the HERA heat pump is able to maintain the constant outlet temperature (LWT) very close to the required Set-point, even when the load variations required by the system (demand) are very high.



Star/Delta Starter or Soft-starter not Required

When larger motors are started, it is necessary in many countries to use equipment that limits the start-up current. In more traditional systems, a star/delta starter or soft-starter is widely used. Such motor starters are not required if a frequency converter is used.

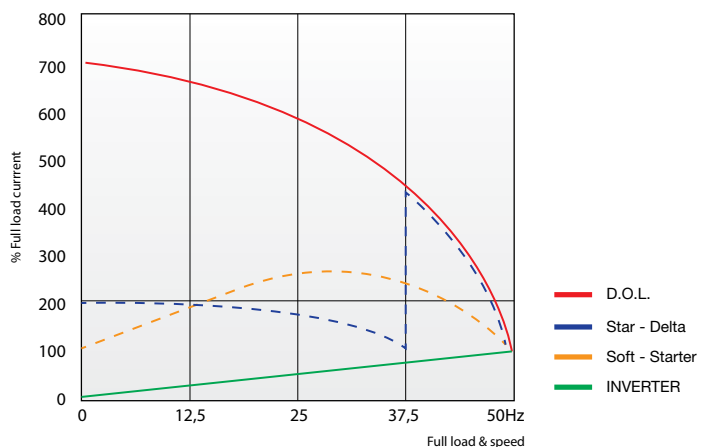

Intelligent Defrosting System

When a heat pump is operating in the heating mode, the outdoor air is relatively cool and the outdoor coil acts as an evaporator. Under certain conditions of temperature and relative humidity, frost might form on the surface of the outdoor coil. The layer of frost will interfere with the operation of the heat pump by making the pump work harder and, therefore, inefficiently. The frost must be removed. A heat pump has a cycle called a defrost cycle, which removes the frost from the outdoor coil.

A heat pump unit will defrost regularly when frost conditions occur. The defrost cycle should be long enough to melt the ice, and short enough to be energy-efficient.

In the defrost cycle, the heat pump is automatically operated in reverse, for a moment, in the cooling cycle. This action temporarily warms up the outdoor coil and melts the frost from the coil.

It is clear that an inadequate defrost or incorrect management of defrost cycles causes a serious inefficiency of the heat pump. To overcome this problem, Euroklimat has carried out a long series of tests in a Laboratory at different temperature and humidity conditions to develop a new algorithm for adjusting the defrost threshold and the time between one defrost and another.



Efficient defrosting

The system is dynamic and thanks to the electronic control, defrost is managed independently to obtain the greatest possible efficiency according with changes in environmental conditions.

Furthermore, the refrigerant circuit is designed to obtain a rapid and very efficient defrosting thanks to its particular management of the refrigerant charge in the two operating cycles.

The software also provides information to the user regarding the efficiency of the heat pump with respect to the number of defrosts planned and those actually carried out, through a score assigned every day, weekly and monthly.

In this way the user can check the efficiency of his HERA heat pump in real time.



HERA

Modular solution | Master & Slave(S)

HERA COLLECT

HERA COLLECT is a cascade unit management system capable of managing up to 5 slave units.

HERA COLLECT consists of a c.pCO Small controller that communicates with the slave units via an Ethernet network in ModBus UDP protocol.

The collectors input and output probes are connected to the system and it is therefore possible to select the type of regulation, on the delivery or return, with a specific parameter.



HERA COLLECT sends the switch-on command via the network to the base unit based on the heating or cooling request, calculated as follows:

- if the temperature remains in the increment zone for a set time, then the number of units required will be increased by one.
- Vice versa, if the temperature remains in the decrement zone for a set time, the number of units required is decreased.
- If the temperature returns to the neutral zone while the timer was active, it is reset.

HERA

Modular solution | Master & Slave(S)

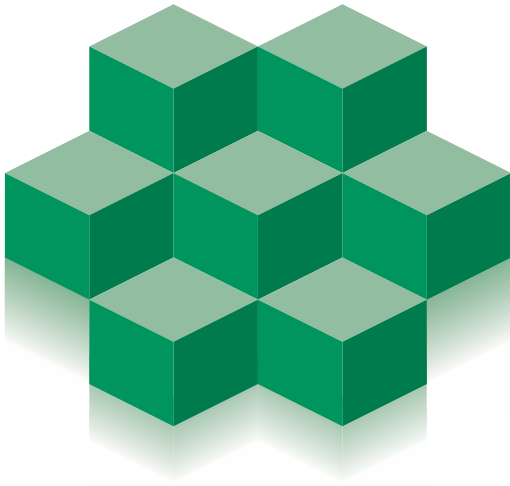

HERA COLLECT

The unit with fewer hours of operation is always activated and the one with more hours off.

Once turned on, the units are sent the request calculated by a PID present on the **HERA COLLECT** in order to align the system.

It is possible to change the operating mode in 3 options through a parameter in the Service menu:

- 1 - From digital input;
- 2 - From keyboard;
- 3 - In Automatic, that is, the outside air temperature is controlled. If the outdoor air temperature is greater than a threshold plus a differential then the operation switches to cooling.

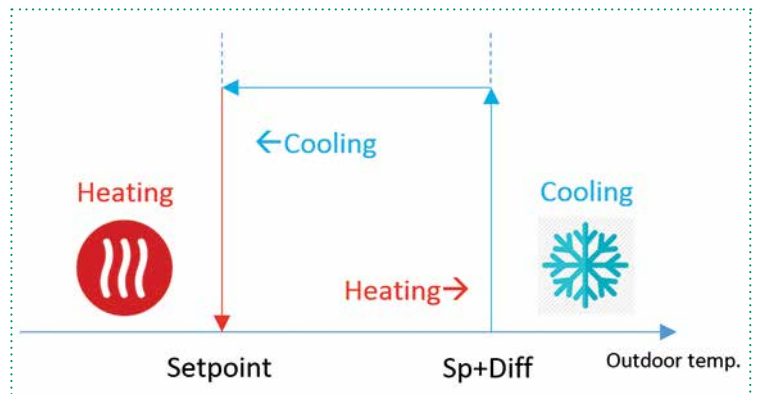

HERA COLLECT always guarantees the functioning of the system, in any condition. If the master is not online, the units will no longer work with the slave mode.

If a slave unit is offline or switched off (not by the master), the unit itself is seen by the master as not available and therefore will not be called upon switching on.

HERA

Advanced Electronic Controller

Thanks to a Multitasking Operating System and to the adoption of standard protocols, local and remote connectivity the controller used in HERA Heat Pumps is the most advanced technology available.



NEW OPERATING SYSTEM

New Multitasking Operating System ensures optimal system resource usage, extended datatypes for user application (32bit floating point numbers) application speed increase and independent protocol engines.



CONNECTIVITY

The controller has two integrated Ethernet interfaces, three serial interfaces and two USB ports.

A great choice of communication protocols is possible (Modbus, Carel, BACNet, LON, Konnex, TCP/IP, HTTP, FTP, DHCP, DNS, NTP, SNMP and many others).



CLOUD SERVICE

Plug & Play solution for tERA platform connection. All tERA services are available just connecting the Ethernet plug to your home or office network, without the need for an external connection box.

HERA

Remote monitoring services tERA



tERA: connectivity, monitoring and remote management systems remote control services.

tERA is the new platform ready to quickly bring the business to the sale of services. Now you can create a centralized remote management system to access quickly and easily all the necessary information.

tERA combines different technological platforms to ensure a cutting-edge solution: mobile connectivity, cloud computing and remote-control SW are integrated into one immediately accessible service.

Retrieve all the information you need at a simple click: you can solve minor configuration problems directly from your office, wherever you are. For more serious problems, fast data analysis gives you all the information you need before taking action and lets you know what components you have to take with you to restore correct system operation. For structural problems, you can connect via remote and upgrade the unit's control SW.



tService is the service of the tERA platform dedicated to the service centre. tService makes maintenance faster and more efficient with a solution ready for remote control.

Functions available are: reading and writing of variables in real time, history with frequencies up to 5", alarm management with notification via e-mail, reports and graphs up to 300 variables, live-trend, SW programmable controls update.

Connectivity to your system is simple and immediate. You can freely choose which communication channel to use during installation: the platform can either use Wireless GSM or an Ethernet line, with secure and reliable solutions. You can access all system information from any device: from your PC in the office, or smartphone or tablet wherever you're working offsite.

GSM solution

If it's hard to connect to the site's network, you can use a channel that works independently from the local infrastructure.

The tERA Wireless GSM lets you access your system using a pre-configured solution through registration on the tERA website in just a few clicks. Data are transmitted over a secure and reliable line: Machine2Machine connectivity (M2M) is available via a protected private channel (VPN).

Ethernet solution

If your site's network is accessible or local mobile phone is not reliable, you can choose the tERA Ethernet subscription.

The installation box is already configured to automatically connect to your system's router. No configuration of static IPs or router parameter settings are required to activate your subscription. With advanced SSL encryption SW, access to your data is secure and fast.

HERA

Refrigerant Circuit Diagram

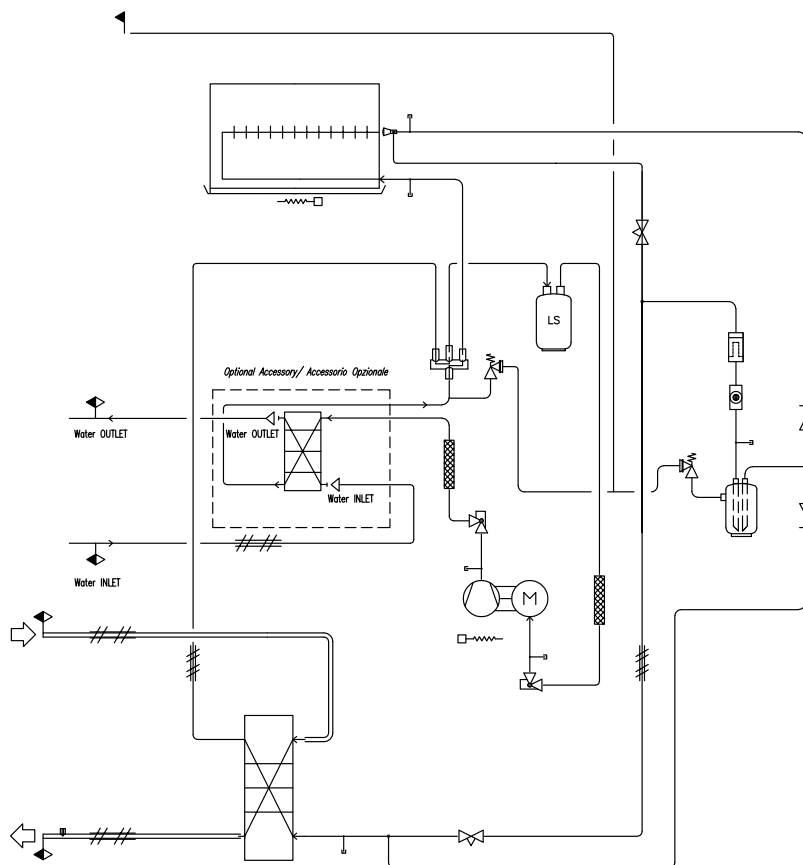

High thickness copper tubes



The copper pipes used for the construction of the refrigeration circuit are of high quality Made in Europe, certified and tested according to the strictest industry standards and offer a greater guarantee of durability thanks to the high thickness.

State-of-the-art brazing



Our welders are all certified and constantly follow training and updating courses on welding techniques. We use a special alloy with silver to obtain an extremely safe and reliable seal over time.

PED test and certification



HERA Heat Pumps are conform to Directive 2014/68 / EU (PED) relating to risk control and safety for pressure equipment, provides for compliance with essential safety requirements of all the systems (assemblies) and of the single equipment operating at a maximum allowable pressure greater than 0.5 relative bar (eg pressure vessels, pipes and accessories) placed on the European market.

HERA

How to select

The below legend allows you to easily select the proper configuration of HERA heat pumps.

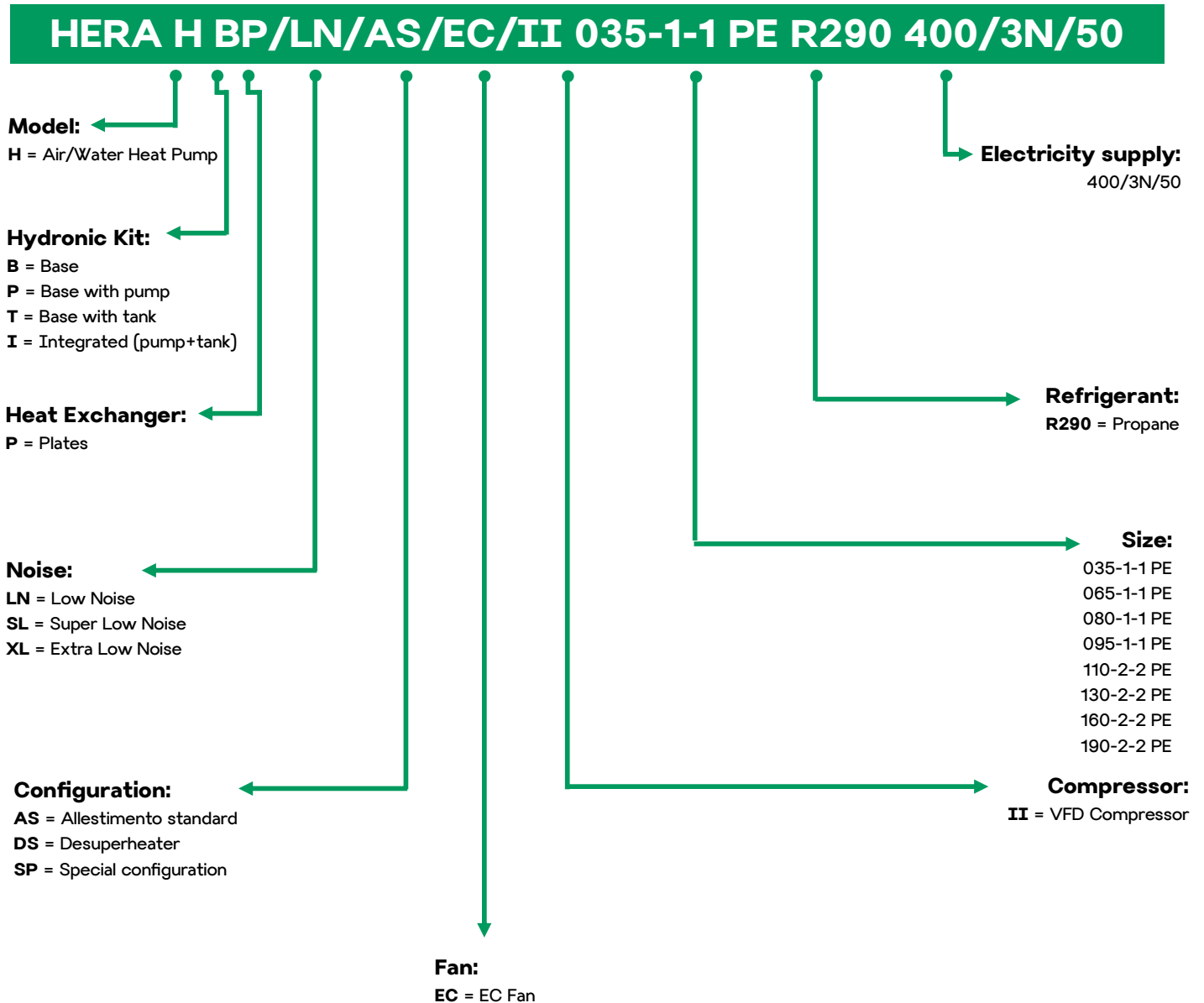

All configurable models comply with current European Directives and Regulations and are accompanied by a declaration of conformity and a CE mark.



HERA



Refrigerant
R290 | GWP=3



Reversible
heat pump



Inverter



Axial fan



Semi-hermetic
piston compressor



Brazen plate
heat exchanger

035-1-1 PE ↔ 095-1-1 PE



SCOP

Air-to-Water reversible Heat Pump for outdoor installation



Solution

- B - Base
- P - Base with pump
- P - Base with tank
- I - Integrated

Version

- LN - Low Noise
- SL - Super Low Noise
- XL - Extra Low Noise

Equipment

- AS - Standard equipment
- DS - Desuperheater

Heating capacity 29,1 - 87,3 kW
Cooling capacity 25,2 - 73,4 kW

Safety system	To ensure high-safety-level the unit is equipped with a special gas detector for flammable gases, explosion-proof ATEX certified, with external dedicated power supply and Modbus output signal. The sensor is provided with an alarm level set at 10% of Lower Flammability Limit (LFL). This alarm activates a red LED status indicator on the control panel and is managed by microprocessor to activate a series of emergency provisions which ensure the highest possible safety level. Ex-rated centrifugal fan, which ensures emergency ventilation inside the compressor's box in case of unlikely R290 leakage.
Structure	Structure specifically designed for outdoor installation. Basement and frame in galvanized shaped sheet steel with a suitable thickness. All parts are polyester-powder painted to assure total weather resistance. For SL and XL versions, the panels are sandwich and insulated with rock wool.
Compressor with INVERTER	Reciprocating semi-hermetic type, fixed on anti-vibration system and complete with pressure lubrication system; oil crankcase heater; integral electronic protection and inlet plus outlet valves; flexible joints on suction and discharge. A VFD (Variable Frequency Drive) is provided in order to adapt the cooling capacity of the reciprocating compressor to the heating or cooling demand. The compressor is mechanically optimized for use with Hydrocarbons. Some components are ATEX certified.
EC Fan	Premium-Axial-Fans with bionic shaped blades and high-efficient EC (Electronically Commutated) external rotor motors, sealed in protection IP54 and thermal class THCL 155. The motor efficiency class complies with IE4.
Air heat exchanger	Finned coil made with copper pipes arranged on staggered rows, mechanically expanded inside a pack of aluminium hydrophilic fins offering a high exchange surface area.
Water heat exchanger Desuperheater (option)	Brazen plate-type heat exchanger, stainless steel AISI 316 made. The heat exchanger design provides high thermal exchange and high-performance results, furthermore it guarantees small dimensions and easy installation and maintenance. Heat exchangers are thermally insulated with closed-cell neoprene anti-condensate material. Air vent valve included.
Electrical board	Each unit is equipped with electric panel, built, wired and fully tested at the factory. Wiring numeration and optimized layout facilitate troubleshooting. The installed components are identified by nameplates to better identify the application and the type of action. Switchboard is made according to standards IEC 204-1/EN60204-1 and it is complete with the following main components: - Main isolator switch - Door interlock safety device - Contactor and protection for compressor and fans - Cabinet minimum protection rating IP54 To ensure higher level of security, the cabinet is outside the machine and positioned on one side of the unit. The propane sensor is equipped with separate power supply: this power supply must always be guaranteed in order to ensure the monitoring of any leakage.
Control	The microprocessor controls the unit capacity by timing the compressors and checks the operating alarms with the possibility to connect to BMS.
Refrigerant circuit	Filter drier, moisture-liquid sight glass, 4-way reversing valve, liquid receiver, liquid separator, shut-off valve on the liquid line, electronic expansion valve, safety high pressure high, high & low pressure gauges. Some components are ATEX certified.
Water circuit (Hydronic Kit – optional)	Water storage tank, material: carbon steel - Treatment: internal and external hot-dip galvanization. Insulation is made with high density rigid polyurethane foam - 30 mm. max. pressure: 6 bar. Water pressure gauge, safety valve, centrifugal pump(s) suitable for glycol solutions up to 20%, manual air venting valve. Variable speed and twin pumps are available as option.

MAIN ACCESSORIES

- Anti-vibration rubber / spring mounts / bell
- Air heat exchanger protection panel or filter (aluminium mesh)
- Air heat exchanger with various coatings treatment
- Overpressure valve / automatic by-pass
- Double water pump (stand-by) - Standard pressure
- Winter kit protection
- Closed expansion vessel with automatic filling unit
- Master / Slave controller for multi-installation

➤ For the complete list of accessories please see pages 32-33

		035-1-1 PE	055-1-1 PE	065-1-1 PE	080-1-1 PE	095-1-1 PE
Heating Capacity ⁽¹⁾ (LN/SL versions)	[kW]	29,1	48,2	61,5	74,0	87,3
Total power input ⁽¹⁾	[kW]	9,0	14,8	20,1	23,1	27,5
COP	[-]	3,24	3,26	3,06	3,20	3,17
Heating Capacity ⁽¹⁾ (XL version)	[kW]	29,4	48,3	58,4	74,0	86,5
Total power input ⁽¹⁾	[kW]	9,0	14,8	20,0	23,0	27,3
COP	[-]	3,26	3,27	2,92	3,21	3,16
Water flow ⁽¹⁾	[m ³ /h]	5,04	8,35	10,17	12,83	15,13
Water pressure drop ⁽¹⁾ - Base version	[kPa]	27	25	35	17	19
Min / Max water flow (heat exchanger, user side)	[m ³ /h]	4,8 / 6,1	7,9 / 10	9,7 / 12,2	12,2 / 15,4	14,4 / 18,2
Applications for seasonal efficiency for heating according to Commission Regulation (EU) No. 813/2013 - Low Temperature - Average Climate						
SCOP (LN/SL-XL)	[W/W]	3,87 - 3,885	3,854 - 3,893	3,541 - 3,55	3,93 - 3,99	3,725 - 3,749
ηsh (LN/SL-XL)	[%]	151,8 - 152,4	151,2 - 152,7	138,6 - 139	154,2 - 156,6	146 - 146,9
Applications for seasonal efficiency for heating according to Commission Regulation (EU) No. 813/2013 - Medium Temperature - Average Climate						
SCOP (LN/SL-XL)	[W/W]	3,077 - 3,089	3,076 - 3,088	3,073 - 3,079	3,149 - 3,173	3,144 - 3,167
ηsh (LN/SL-XL)	[%]	120,1 - 120,5	120 - 120,5	119,9 - 120,1	123 - 123,9	122,8 - 123,7
Energy efficiency class according to Regulation EU No. 811/2013 - low temperature heat pumps ≤ 70kW						
Seasonal space heating energy efficiency class	-	A+	A+	A+	#	#
Cooling Capacity ⁽²⁾ (LN/SL versions)	[kW]	25,2	41,7	52,4	63,2	73,4
Total power input ⁽²⁾	[kW]	9,8	16,3	21,7	25,5	30,9
EER	[-]	2,58	2,56	2,42	2,48	2,37
Cooling Capacity ⁽²⁾ (XL version)	[kW]	25,2	41,6	52,3	62,9	73,5
Total power input ⁽²⁾	[kW]	9,7	16,1	21,5	25,2	30,6
EER	[-]	2,60	2,58	2,44	2,50	2,40
Water flow ⁽²⁾	[m ³ /h]	4,3	7,2	9,0	10,9	12,6
Water pressure drop ⁽²⁾ - Base version	[kPa]	21	19	28	13	14
Min / Max water flow (heat exchanger, user side)	[m ³ /h]	3,5 / 5,2	5,7 / 8,6	7,2 / 10,8	8,7 / 13	10,1 / 15,2
Technical data						
Refrigerant / GWP	-			R290 / 3		
Charge of refrigerant	[Kg]	4,1	5,8	6,1	8,4	8,8
Refrigerant circuit	N°			1		
Compressor type / quantity	-/N°			Semihhermetic reciprocating with VFD (Variable Frequency Drive) / 1		
Expansion valve type	-			Electronic		
Fans type / quantity	-	1 / Axial EC	2 / Axial EC	2 / Axial EC	3 / Axial EC	3 / Axial EC
Fans power input ⁽¹⁾ (total)	[kW]	0,20	0,40	0,54	0,67	0,72
Total air flow	[m ³ /h]	8.200	15.500	15.900	24.000	24.200
Electrical data						
Power supply (main - gas detector)	-			400/3+N/50 - 230/1/50		
Maximum absorbed power	[kW]	13,2	21,3	27,3	31,5	38,5
Locked rotor current - LRA	[A]			< 10		
Maximum absorbed current (full load)	[A]	21,8	37	47,8	56,9	67,8
Solution INTEGRATA - with Hydronic Kit						
Buffer tank capacity	[L]			300		
Pump type	-			Centrifugal		
Standard pump (1,5 bar)						
Motor efficiency	-			IE3		
Pump motor nominal power input	[kW]	0,55	1,1	1,1	1,5	1,5
Pump motor nominal absorbed current	[A]	1,85	3,3	3,3	3,8	3,8
Increased pump (3,0 bar)						
Motor efficiency	-			IE3		
Pump motor nominal power input	[kW]	1,5	2,2	2,2	3,0	3,0
Pump motor nominal absorbed current	[A]	4,1	4,7	4,7	6,4	6,4
Water connections						
Size (nominal external diameter)	[inch]	1"	1" ¼	1" ¼	2"	2"
Noise levels ⁽³⁾						
Total sound power (LN version)	[db(A)]	78,0	86,0	86,0	88,0	88,0
Total sound pressure (LN version) - at 1 m distance	[db(A)]	70,0	78,0	78,0	80,0	80,0
Total sound pressure (LN version) - at 10 m distance	[db(A)]	50,0	58,0	58,0	60,0	60,0
Total sound power (SL version)	[db(A)]	76,0	82,0	82,0	84,0	85,0
Total sound pressure (SL version) - at 1 m distance	[db(A)]	68,0	74,0	74,0	76,0	77,0
Total sound pressure (SL version) - at 10 m distance	[db(A)]	48,0	54,0	54,0	56,0	57,0
Total sound power (XL version)	[db(A)]	75,0	80,0	80,0	82,0	84,0
Total sound pressure (XL version) - at 1 m distance	[db(A)]	67,0	72,0	72,0	74,0	76,0
Total sound pressure (XL version) - at 10 m distance	[db(A)]	47,0	52,0	52,0	54,0	56,0
Dimensions and weights - unit						
Length	[mm]	1.750	2.400	2.400	3.200	3.200
Width	[mm]	1.050	1.050	1.050	1.050	1.050
Height (LN, SN)	[mm]	1.900	1.900	1.900	1.900	1.900
Height (XL)	[mm]	1.985	1.985	1.985	1.985	1.985
Shipping weight - BP/LN/AS/EC/II version	[Kg]	490	600	660	820	820
Shipping weight - BP/SL/AS/EC/II version	[Kg]	530	670	720	880	880
Shipping weight - BP/XL/AS/EC/II version	[Kg]	530	670	720	880	880
Dimensions of the Hydronic kit						
Length	[mm]	1050	1050	1050	1050	1050
Width	[mm]	900	900	900	900	900
Height	[mm]	1670	1670	1670	1670	1670

Reference conditions:

- Outdoor ambient air = +7°C / 87% r.h. - Condenser water temperature IN/OUT = 40/45°C - Fluid: water
- Condenser air intake temperature = 35°C - Evaporator water temperature IN/OUT = 12/7°C - Fluid: water
- The declared cooling capacity are not taking into account the pump motor power input (where provided).
- The sound pressure level (average value) is calculated considering the unit as a point source with hemispherical emission with the presence of the support plane with hypotheses of complete reflectivity (non-binding value obtained from the sound power level).

Compliance with "Eco-Design"

The units comply with the European Directive 2009/125/EC and the Commission Regulation (EU) 813/2013, with the Harmonized Directives. The relevant information related to each model are published on our website www.euroklimat.it

HERA

R290

Refrigerant
R290 | GWP=3



Reversible
heat pump



Inverter



Axial fan



Semi-hermetic
piston compressor



Brazen plate
heat exchanger

110-2-2 PE ↔ 190-2-2 PE



SCOP

Air-to-Water reversible Heat Pump for outdoor installation



Solution

- B - Base
- P - Base with pump
- P - Base with tank
- I - Integrated

Version

- LN - Low Noise
- SL - Super Low Noise
- XL - Extra Low Noise

Equipment

- AS - Standard equipment
- DS - Desuperheater

Heating capacity 96,2 - 174,3 kW
Cooling capacity 82,2 - 146,4 kW

Safety system	To ensure high-safety-level the unit is equipped with a special gas detector for flammable gases, explosion-proof ATEX certified, with external dedicated power supply and Modbus output signal. The sensor is provided with an alarm level set at 10% of Lower Flammability Limit (LFL). This alarm activates a red LED status indicator on the control panel and is managed by microprocessor to activate a series of emergency provisions which ensure the highest possible safety level. Ex-rated centrifugal fan, which ensures emergency ventilation inside the compressor's box in case of unlikely R290 leakage.
Structure	Structure specifically designed for outdoor installation. Basement and frame in galvanized shaped sheet steel with a suitable thickness. All parts are polyester-powder painted to assure total weather resistance. For SL and XL versions, the panels are sandwich and insulated with rock wool.
Compressor with INVERTER	Reciprocating semi-hermetic type, fixed on anti-vibration system and complete with pressure lubrication system; oil crankcase heater; integral electronic protection and inlet plus outlet valves; flexible joints on suction and discharge. A VFD (Variable Frequency Drive) is provided in order to adapt the cooling capacity of the reciprocating compressor to the heating or cooling demand. The compressor is mechanically optimized for use with Hydrocarbons. Some components are ATEX certified.
EC Fan	Premium-Axial-Fans with bionic shaped blades and high-efficient EC (Electronically Commutated) external rotor motors, sealed in protection IP54 and thermal class THCL 155. The motor efficiency class complies with IE4.
Air heat exchanger	Finned coil made with copper pipes arranged on staggered rows, mechanically expanded inside a pack of aluminium hydrophilic fins offering a high exchange surface area.
Water heat exchanger Desuperheater (option)	Brazen plate-type heat exchanger, stainless steel AISI 316 made. The heat exchanger design provides high thermal exchange and high-performance results, furthermore it guarantees small dimensions and easy installation and maintenance. Heat exchangers are thermally insulated with closed-cell neoprene anti-condensate material. Air vent valve included.
Electrical board	Each unit is equipped with electric panel, built, wired and fully tested at the factory. Wiring numeration and optimized layout facilitate troubleshooting. The installed components are identified by nameplates to better identify the application and the type of action. Switchboard is made according to standards IEC 204-1/EN60204-1 and it is complete with the following main components: - Main isolator switch - Door interlock safety device - Contactor and protection for compressor and fans - Cabinet minimum protection rating IP54 To ensure higher level of security, the cabinet is outside the machine and positioned on one side of the unit. The propane sensor is equipped with separate power supply: this power supply must always be guaranteed in order to ensure the monitoring of any leakage.
Control	The microprocessor controls the unit capacity by timing the compressors and checks the operating alarms with the possibility to connect to BMS.
Refrigerant circuit	Filter drier, moisture-liquid sight glass, 4-way reversing valve, liquid receiver, liquid separator, shut-off valve on the liquid line, electronic expansion valve, safety high pressure high, high & low pressure gauges. Some components are ATEX certified.
Water circuit (Hydronic Kit – optional)	Water storage tank, material: carbon steel - Treatment: internal and external hot-dip galvanization. Insulation is made with high density rigid polyurethane foam - 30 mm. max. pressure: 6 bar. Water pressure gauge, safety valve, centrifugal pump(s) suitable for glycol solutions up to 20%, manual air venting valve. Variable speed and twin pumps are available as option.

MAIN ACCESSORIES

- Anti-vibration rubber / spring mounts / bell
- Air heat exchanger protection panel or filter (aluminium mesh)
- Air heat exchanger with various coatings treatment
- Overpressure valve / automatic by-pass
- Double water pump (stand-by) - Standard pressure
- Winter kit protection
- Closed expansion vessel with automatic filling unit
- Master / Slave controller for multi-installation

➤ For the complete list of accessories please see pages 32-33

		110-2-2 PE	130-2-2 PE	160-2-2 PE	190-2-2 PE
Heating Capacity ⁽¹⁾ (LN/SL versions)	[kW]	96,2	118,0	147,4	174,3
Total power input ⁽¹⁾	[kW]	29,5	39,7	46,6	55,6
COP	[-]	3,26	2,97	3,17	3,14
Heating Capacity ⁽¹⁾ (XL version)	[kW]	96,5	124,2	147,4	174,2
Total power input ⁽¹⁾	[kW]	29,4	39,7	46,4	55,4
COP	[-]	3,28	3,13	3,18	3,14
Water flow ⁽¹⁾	[m ³ /h]	16,67	20,50	25,54	30,19
Water pressure drop ⁽¹⁾ - Base version	[kPa]	21	21	26	31
Min / Max water flow (heat exchanger, user side)	[m ³ /h]	15,8 / 20	19,5 / 24,6	24,3 / 30,6	28,7 / 36,2
Applications for seasonal efficiency for heating according to Commission Regulation (EU) No. 813/2013 - Low temperature - Average Climate					
SCOP (LN/SL-XL)	[W/W]	4,094 - 4,126	3,821 - 3,857	4,104 - 4,177	3,822 - 3,866
η _{sh} (LN/SL-XL)	[%]	160,8 - 162	149,9 - 151,3	161,2-164,1	149,9-151,7
Applications for seasonal efficiency for heating according to Commission Regulation (EU) No. 813/2013 - Medium temperature - Average Climate					
SCOP (LN/SL-XL)	[W/W]	3,354-3,386	3,205-3,424	3,418-3,453	3,408-3,436
η _{sh} (LN/SL-XL)	[%]	131,2-132,4	125,2-134	133,7-135,1	133,3-134,4
Energy efficiency class according to Regulation EU no. 811/2013 - low temperature heat pumps ≤ 70kW					
Seasonal space heating energy efficiency class	-	#	#	#	#
Cooling Capacity ⁽²⁾ (LN/SL versions)	[kW]	82,2	102,4	126,0	146,4
Total power input ⁽²⁾	[kW]	32,7	44,6	51,0	61,8
EER	[-]	2,52	2,30	2,47	2,37
Cooling Capacity ⁽²⁾ (XL version)	[kW]	83,2	102,4	125,8	146,6
Total power input ⁽²⁾	[kW]	32,3	44,1	50,4	61,2
EER	[-]	2,57	2,32	2,49	2,40
Water flow ⁽²⁾	[m ³ /h]	14,2	17,6	21,7	25,2
Water pressure drop ⁽²⁾ - Base version	[kPa]	18	17	21	24
Min / Max water flow (heat exchanger, user side)	[m ³ /h]	11,3 / 17	14,1 / 21,1	17,4 / 26	20,2 / 30,32
Technical data					
Refrigerant / GWP	-	R290 / 3			
Charge of refrigerant	[kg]	11,6	12,2	16,8	17,6
Refrigerant circuit	N°	2			
Compressor type / quantity	- / N°	Semihermetic reciprocating with VFD (Variable Frequency Drive) / 2			
Expansion valve type	-	Electronic			
Fans quantity / type	- /	4 / Axial EC	4 / Axial EC	6 / Axial EC	6 / Axial EC
Fans power input ⁽¹⁾ (total)	[kW]	1,04	1,34	1,34	1,41
Total air flow	[m ³ /h]	33.100	47.200	47.200	48.100
Electrical data					
Power supply (main - gas detector)	-	400/3+N/50 - 230/1/50			
Maximum absorbed power	[kW]	42,6	54,6	62,9	76,9
Locked rotor current - LRA	[A]	< 10			
Maximum absorbed current (full load)	[A]	74,0	95,6	113,8	135,6
Solution INTEGRATA - with Hydronic Kit					
Buffer tank capacity	[L]	290		470	
Pump type	-	Centrifugal			
Standard pump (1,5 bar)					
Motor efficiency	-	IE3			
Pump motor nominal power input	[kW]	1,5	1,5	2,2	2,2
Pump motor nominal absorbed current	[A]	3,8	3,8	4,7	4,7
Increased pump (3,0 bar)					
Motor efficiency	-	IE3			
Pump motor nominal power input	[kW]	4	4	4	4
Pump motor nominal absorbed current	[A]	8,7	8,7	8,7	8,7
Water connections					
Size (nominal external diameter)	[inch]	2"	2"	2" ½	2" ½
Noise levels ⁽³⁾					
Total sound power (LN version)	[db(A)]	88,0	88,0	90,0	90,0
Total sound pressure (LN version) - at 1 m distance	[db(A)]	80,0	80,0	82,0	82,0
Total sound pressure (LN version) - at 10 m distance	[db(A)]	60,0	60,0	62,0	62,0
Total sound power (SL version)	[db(A)]	85,0	85,0	87,0	87,0
Total sound pressure (SL version) - at 1 m distance	[db(A)]	77,0	77,0	79,0	79,0
Total sound pressure (SL version) - at 10 m distance	[db(A)]	57,0	57,0	59,0	59,0
Total sound power (XL version)	[db(A)]	83,0	83,0	85,0	85,0
Total sound pressure (XL version) - at 1 m distance	[db(A)]	75,0	75,0	77,0	77,0
Total sound pressure (XL version) - at 10 m distance	[db(A)]	55,0	55,0	57,0	57,0
Dimensions and weights - Solution B (BASE) unit					
Length	[mm]	3.190	3.190	4.090	4.090
Width	[mm]	2.100	2.100	2.100	2.100
Height (LN, SL)	[mm]	1.900	1.900	1.900	1.900
Height (XL)	[mm]	1.985	1.985	1.985	1.985
Shipping weight - B/LN/AS version	[Kg]	1.300	1.420	1.650	1.650
Shipping weight - B/SL/AS version	[Kg]	1.370	1.480	1.720	1.720
Shipping weight - B/XL/AS version	[Kg]	1.370	1.480	1.720	1.720

Reference conditions:

- Outdoor ambient air = +7°C / 87% r.h. - Condenser water temperature IN/OUT = 40/45°C - Fluid: water
- Condenser air intake temperature = 35°C - Evaporator water temperature IN/OUT = 12/7°C - Fluid: water
- The declared cooling capacity are not taking into account the pump motor power input (where provided).
- The sound pressure level (average value) is calculated considering the unit as a point source with hemispherical emission with the presence of the support plane with hypotheses of complete reflectivity (non-binding value obtained from the sound power level).

Compliance with "Eco-Design"

The units comply with the European Directive 2009/125/EC and the Commission Regulation (EU) 813/2013, with the Harmonized Directives. The relevant information related to each model are published on our website www.euroklimat.it

HERA

Customizable

Anti-vibration mounts

3514-010: Anti-vibration spring mounts (supplied separately)



Spring anti-vibration mounts to be installed under the unit (supplied in kit). These accessories allow to avoid the transmission of possible vibrations from the machine to the structure that supports the unit itself. Provided with anchor points, therefore it is possible to connect them to the ground or to the structure that supports the unit.

3514-020: Anti-vibration seismic spring mounts (supplied separately)



Anti-seismic spring anti-vibration mounts to be installed under the unit (supplied in kit). These accessories allow to avoid the transmission of possible vibrations from the machine to the structure that supports the unit itself. Provided with anchor points, therefore it is possible to connect them to the ground or to the structure that supports the unit.

3514-030: Anti-vibration rubber mounts (supplied separately)



Rubber anti-vibration mounts to be installed under the unit (supplied in kit). These accessories allow to avoid the transmission of possible vibrations from the machine to the structure that supports the unit itself. They do not have anchor points, so it is not possible to connect them to the ground or structure that supports the unit.

3514-040: Bell anti-vibration mounts (supplied separately)



Bell anti-vibration mounts to be installed under the unit (supplied in kit). Provided with anchor points, therefore it is possible to connect them to the ground or to the structure that supports the unit. These accessories allow to avoid the transmission of possible vibrations from the machine to the structure that supports the unit itself.

Exchanger treatments

5017-020: Finned pack heat exchanger Copper/Copper



Finned pack heat exchanger consisting of copper pipes and fins. This solution allows to increase the heat exchange efficiency and the machine performance.

Electric switchboard

8550-020: Anti-condensation heater with thermostat



Thermal resistance with the function of maintaining a temperature inside the electrical panel higher than the dew temperature to avoid the formation of condensation that could damage the components inside it.

8550-070: Device for measuring the electric energy consumed (Energy meter)



Measuring instrument dedicated to the detection of the main electrical parameters and the consumption of the connected loads. Energy meter records power consumption and allows a complete and detailed analysis of measured data.

8550-060: Emergency power supply for electronic expansion valve (Ultracap module)



Ultracap is an emergency power supply device for systems that use electronic expansion valves: this device ensures complete closing of the valves even when there are sudden mains power failures.

8550-121: Minimum and maximum voltage control relay



Relay for checking the power supply voltage values mounted directly inside the electrical panel. This component stops the appliances connected to the electrical network if the supply voltage is outside the tolerance range.

Electronic control

8065-080: Remote control panel



Remote user terminal that can be used to view all readings and duplicate commands on an additional display located remotely and in a more accessible place than the on-board microprocessor. Communication via Modbus protocol (RS485 communication standard).

Connectivity



Most of the common communication protocols are available for integration with the BMS.

HERA

Accessories

Water circuit

6010-010: Differential pressure switch hydraulic circuit



Differential pressure meter transmitter with the function of controlling the failure or reduced flow of the secondary fluid.

6010-020: Electromechanical flow switch hydraulic circuit - Evaporator (supplied separately)



Electromechanical flow switch with the function of controlling the failure or reduced flow of secondary fluid to the evaporator. The component is supplied with the machine and the installer will carry out the correct mechanical assembly and connection to the electrical panel of the unit.

6010-040: Manual air vent valve



Manual air vent valve which allows to discharge the air contained in the hydraulic circuit.

6010-091: Automatic overpressure by-pass valve hydraulic circuit



Automatic by-pass valve whose function is to control the pressure at the discharge of the electric pump to avoid dangerous overpressures in the hydraulic circuit in correspondence with the users. The valve, which is installed on the unit, allows to carry out a recirculation of the secondary fluid on the tank or on the evaporator, thus reducing the discharge pressure according to the characteristic curve of the installed pump. Everything happens automatically and this accessory is very useful in hydraulic systems that can work with significant variations in flow.

Increased water pressure pump



See page 39 for available hydronic solutions

Pressure relief valve (4,5 bar setting)



Pressure relief valve for hydraulic circuit (4,5 bar setting).

6010-023: Electronic flow switch hydraulic circuit - Evaporator (supplied separately)



Electromechanical flow switch with the function of controlling the failure or reduced flow of secondary fluid to the evaporator. The component is supplied already mechanically mounted on the machine and electrically connected to the unit's electrical panel.

6010-041: Automatic air vent valve



Automatic air vent valve which allows to discharge the air contained in the hydraulic circuit.

6010-111: Closed expansion tank with filling valve/pressure reducer



Closed expansion vessel to contain volume variations of the fluid contained in the hydraulic circuit. The fluid is in contact with a membrane that separates it from a chamber containing gas. Filling takes place through a special automatic valve and is complete with pressure reducer.

Double water pump



See page 39 for available hydronic solutions

HERA

Standard equipment and Accessories

EK ref. CODE	HERA	035-1-1 PE	055-1-1 PE	065-1-1 PE	080-1-1 PE	095-1-1 PE	110-2-2 PE	130-2-2 PE	160-2-2 PE	190-2-2 PE
Generic										
-	Compliance with EcoLabel Regulation (811/2013/EU)	●	●	●	N.A.	N.A.	N.A.	N.A.	N.A.	N.A.
-	Applications for seasonal efficiency for heating according to Commission Regulation (EU) No 813/2013 - SCOP	●	●	●	●	●	●	●	●	●
-	Compliance with PED Directive (2014/68/EU)	●	●	●	●	●	●	●	●	●
Transport and packaging										
3517-010	Locking system for long distance transport	○	○	○	○	○	○	○	○	○
3517-030	Packaging with wooden cage without base (non-fumigated wood)	○	○	○	○	○	-	-	-	-
3517-036	Standard packaging (heat-shrinkable plastic film)	●	●	●	●	●	●	●	●	●
3517-037	Standard packaging with wooden base	○	○	○	○	○	-	-	-	-
3517-050	Unit charged with R290 (ADR transport, if required, must be managed the customer)	●	●	●	●	●	●	●	●	●
3517-060	Unit discharged - circuit under pressure with nitrogen charge	○	○	○	○	○	○	○	○	○
Anti-vibration mounts										
3514-010	Anti-vibration spring mounts (supplied separately)	○	○	○	○	○	○	○	○	○
3514-020	Anti-vibration seismic spring mounts (supplied separately)	-	○	○	○	○	○	○	○	○
3514-030	Anti-vibration rubber mounts (supplied separately)	○	○	○	○	○	○	○	○	○
3514-040	Bell anti-vibration mounts (supplied separately)	○	○	○	○	○	○	○	○	○
3514-011	Anti-vibration spring mounts (supplied separately) for hydronic kit	○	○	○	○	○	-	-	-	-
3514-021	Anti-vibration seismic spring mounts (supplied separately) for hydronic kit	-	○	○	○	○	-	-	-	-
3514-031	Anti-vibration rubber mounts (supplied separately) for hydronic kit	○	○	○	○	○	-	-	-	-
3514-041	Bell anti-vibration mounts (supplied separately) for hydronic kit	○	○	○	○	○	-	-	-	-
Paint										
3100-010	Standard painting, colour RAL 7035	●	●	●	●	●	●	●	●	●
3100-011	Standard painting, RAL on request	○	○	○	○	○	○	○	○	○
Mechanical protections										
3113-041	Aluminum mesh filter (single mesh) for air heat exchangers	○	○	○	○	○	○	○	○	○
Cold climates kit										
-	Self-regulating heating cable for the condensate collection tray	●	●	●	●	●	●	●	●	●
3199-010	Canopy protection kit in galvanized sheet for finned heat exchanger	○	○	○	○	○	○	○	○	○
3199-011	Canopy protection kit in painted galvanized sheet for finned heat exchanger	○	○	○	○	○	○	○	○	○
3199-012	Canopy protection kit in stainless steel (AISI 304) for finned heat exchanger	○	○	○	○	○	○	○	○	○
3199-020	Support frame kit in galvanized sheet	○	○	○	○	○	○	○	○	○
3199-021	Support frame kit in painted galvanized sheet	○	○	○	○	○	○	○	○	○
3199-022	Support frame kit in stainless steel (AISI 304)	○	○	○	○	○	○	○	○	○
3199-030	Fan duct kit in galvanized sheet	○	○	○	○	○	○	○	○	○
3199-031	Fan duct kit in painted galvanized sheet	○	○	○	○	○	○	○	○	○
3199-032	Fan duct kit in stainless steel (AISI 304)	○	○	○	○	○	○	○	○	○

●	standard equipment	○	optional	-	not available	N.A.	not applicable
---	--------------------	---	----------	---	---------------	------	----------------

Standard equipment and Accessories

EK ref. CODE	HERA	035-1-1 PE	055-1-1 PE	065-1-1 PE	080-1-1 PE	095-1-1 PE	110-2-2 PE	130-2-2 PE	160-2-2 PE	190-2-2 PE
--------------	------	------------	------------	------------	------------	------------	------------	------------	------------	------------

Compressor										
5010-030	Compressor crankcase oil heater	●	●	●	●	●	●	●	●	●
5010-070	Compressor oil charge	●	●	●	●	●	●	●	●	●

Fans										
-	EC Fans (brushless motor)	●	●	●	●	●	●	●	●	●

Exchanger treatments										
5017-005	Finned pack heat exchanger Copper/Aluminum with hydrophilic coating	●	●	●	●	●	●	●	●	●
5017-020	Finned pack heat exchanger Copper/Copper	○	○	○	○	○	○	○	○	○

Refrigerant circuit										
5030-010	Pressure transducer (LP side - low pressure)	●	●	●	●	●	●	●	●	●
5030-011	Pressure transducer (HP side - high pressure)	●	●	●	●	●	●	●	●	●
5030-020	Safety pressure switch (LP side - low pressure)	○	○	○	○	○	○	○	○	○
5030-021	Safety pressure switch (HP side - high pressure)	●	●	●	●	●	●	●	●	●
5030-030	Glycerine pressure gauges (high and low pressure sides)	●	●	●	●	●	●	●	●	●
5030-040	Compressor suction and discharge valve	●	●	●	●	●	●	●	●	●
5030-051	Electronic expansion valve	●	●	●	●	●	●	●	●	●
5030-060	Safety valve with conveyed discharge (HP side - high pressure)	●	●	●	●	●	●	●	●	●
5030-061	Safety valve with conveyed discharge (LP side - low pressure)	●	●	●	●	●	●	●	●	●

Water circuit										
6010-010	Differential pressure switch hydraulic circuit	●	●	●	●	●	●	●	●	●
6010-020	Electromechanical flow switch hydraulic circuit - Evaporator (supplied separately)	○	○	○	○	○	○	○	○	○
6010-023	Electronic flow switch hydraulic circuit - Evaporator (supplied separately)	○	○	○	○	○	○	○	○	○
6010-040	Manual air vent valve	●	●	●	●	●	●	●	●	●
6010-041	Automatic air vent valve	○	○	○	○	○	○	○	○	○
-	Thermal insulation - thickness 9 mm	●	●	●	●	●	●	●	●	●
6010-072	Water filter 350 microns (supplied separately)	○	○	○	○	○	○	○	-	-
6010-075	Water filter 800 microns (supplied separately)	-	-	-	-	-	-	-	○	○
6010-080	Water pipes with electric resistance for antifreeze and thermostat	○	○	○	○	○	○	○	○	○
6010-091	Automatic overpressure by-pass valve hydraulic circuit	○	○	○	○	○	○	○	-	-
6010-101	Flanges for water fittings (carbon steel A105 PN10)	○	○	○	○	○	○	○	○	○
6010-102	Flanges for water fittings (AISI 304L PN10)	○	○	○	○	○	○	○	○	○
6010-103	Flanges and counter-flanges for water fittings (carbon steel A105 PN10)	○	○	○	○	○	○	○	○	○
6010-104	Flanges and counter-flanges for water fittings (AISI 304L PN10)	○	○	○	○	○	○	○	○	○
6010-111	Closed expansion tank with filling valve/pressure reducer - ONLY FOR INTEGRATA SOLUTION	●	●	●	●	●	●	●	●	●
6010-112	Closed expansion tank without filling valve/pressure reducer - ONLY FOR INTEGRATA SOLUTION	○	○	○	○	○	○	○	○	○
6010-120	Pump start-up for antifreeze prevention	●	●	●	●	●	●	●	●	●
6010-151	Pump suction valve	○	○	○	○	○	○	○	●	●
6010-152	Pump discharge valve	○	○	○	○	○	○	○	○	○

●	standard equipment	○	optional	-	not available	N.A.	not applicable
---	--------------------	---	----------	---	---------------	------	----------------

HERA

Standard equipment and Accessories

EK ref. CODE	HERA	035-1-1 PE	055-1-1 PE	065-1-1 PE	080-1-1 PE	095-1-1 PE	110-2-2 PE	130-2-2 PE	160-2-2 PE	190-2-2 PE
--------------	------	------------	------------	------------	------------	------------	------------	------------	------------	------------

Safety devices										
5033-011	ATEX Gas detector with separate electrical supply	●	●	●	●	●	●	●	●	●
5033-012	Double gas detector with separate electrical supply	○	○	○	○	○	○	○	○	○
5033-020	Calibration kit for refrigerant leak detector	○	○	○	○	○	○	○	○	○
5033-030	ATEX extraction fan activated in case of R290 leakage	●	●	●	●	●	●	●	●	●
5033-031	ATEX extraction fan activated in case of R290 leakage (increased pressure)	○	○	○	○	○	○	○	○	○
5033-040	Rectangular flange for extraction fan's discharge side (supplied separately)	○	○	○	○	○	○	○	○	○
5033-041	Circular flange for extraction fan's discharge side (supplied separately)	○	○	○	○	○	○	○	○	○
5033-050	Air flow-switch (supplied separately, fully integrated control logic management)	○	○	○	○	○	○	○	○	○
5033-060	Audible alarm activated in case of R290 leak detection	○	○	○	○	○	○	○	○	○

Electric switchboard										
8550-020	Anti-condensation heater with thermostat	○	○	○	○	○	○	○	○	○
8550-031	Electrical panel service lamp	○	○	○	○	○	○	○	○	○
8550-040	Service socket outlet 230V AC - max. 150 Watt	○	○	○	○	○	○	○	○	○
8550-050	Emergency button	○	○	○	○	○	○	○	○	○
8550-060	Emergency power supply for electronic expansion valve (Ultracap module)	○	○	○	○	○	○	○	○	○
8550-070	Device for measuring the electric energy consumed (Energy meter)	○	○	○	○	○	○	○	○	○
8550-080	Electrical Panel weather protection cover	●	●	●	●	●	●	●	●	●
8550-090	Device locking doors windproof cabinet	●	●	●	●	●	●	●	●	●
8550-100	Minimum protection class of the electrical panel equal to IP54	●	●	●	●	●	●	●	●	●
8550-109	Power supply with neutral	●	●	●	●	●	●	●	●	●
8550-110	Power supply without neutral	○	○	○	○	○	○	○	○	○
8550-121	Minimum and maximum voltage control relay	○	○	○	○	○	○	○	○	○
8550-150	Emergency power supply 230V/1 ph/50Hz	●	●	●	●	●	●	●	●	●

●	standard equipment	○	optional	-	not available	N.A.	not applicable
---	--------------------	---	----------	---	---------------	------	----------------

HERA

Standard equipment and Accessories

EK ref. CODE	HERA	035-1-1 PE	055-1-1 PE	065-1-1 PE	080-1-1 PE	095-1-1 PE	110-2-2 PE	130-2-2 PE	160-2-2 PE	190-2-2 PE
--------------	------	------------	------------	------------	------------	------------	------------	------------	------------	------------

Electronic control										
8065-011	Integrated Electronic Security module installed inside the electrical board	-	●	●	●	●	●	●	●	●
8065-020	Set point compensation by outside temperature	○	○	○	○	○	○	○	○	○
8065-030	ModBus® interface (RS 485)	○	○	○	○	○	○	○	○	○
8065-033	BACnet® TCP/IP interface	○	○	○	○	○	○	○	○	○
8065-040	Software updates via USB port	●	●	●	●	●	●	●	●	●
8065-041	Updates with transferring files through FTP	○	○	○	○	○	○	○	○	○
8065-051	"Cloud GATE" device for monitoring and remote management services - Ethernet connection	●	●	●	●	●	●	●	●	●
8065-053	"Cloud GATE" device for monitoring and remote management services - 4G connection	○	○	○	○	○	○	○	○	○
8065-054	Device for monitoring and remote management services - VPN Connection	○	○	○	○	○	○	○	○	○
8065-062	Advanced electronic controller (c.pCO)	●	●	●	●	●	●	●	●	●
8065-071	Token for remote monitoring and service management "Cloud GATE" - Ethernet connection - AREA 1 (1 year) (*)	○	○	○	○	○	○	○	○	○
8065-073	Token for remote monitoring and service management "Cloud GATE" - 4G connection - AREA 1 (1 year) (*)	○	○	○	○	○	○	○	○	○
8065-080	Remote control panel	○	○	○	○	○	○	○	○	○
8065-090	Integrated control of the electronic expansion valve	●	●	●	●	●	●	●	●	●
8065-100	Operating hour meter	●	●	●	●	●	●	●	●	●
8065-110	Prevent compressor operating limits (envelope control)	●	●	●	●	●	●	●	●	●
8065-120	Alarm history	●	●	●	●	●	●	●	●	●
8065-130	Second set-point from digital input	○	○	○	○	○	○	○	○	○
8065-140	Remote On/Off digital input	●	●	●	●	●	●	●	●	●
8065-150	HERA COLLECT I Cascade unit management system (max. 6 units). Composed of c.pCO small + terminal + 2 NTC probes 12 mt.	○	○	○	○	○	○	○	○	○

(*) Token for AREA 1 which includes the following countries (duration 1 year):

Albania, Australia, Austria, Belgium, Bulgaria, Cyprus, Czech Republic, Denmark, Egypt, Estonia, Finland, France, Germany, Greece, Hungary, Ireland, Italy, Latvia, Lithuania, Luxembourg, Malta, Netherlands, New Zealand, Norway, Poland, Portugal, Romania, South Africa, Spain, Sweden, Switzerland, Turkey, United Kingdom.

●	standard equipment	○	optional	-	not available	N.A.	not applicable
---	--------------------	---	----------	---	---------------	------	----------------

HERA

Plug & Play solution | Hydronic Kit

For single circuit units (from 035-1-1 to 095-1-1) the HERA hydronic kit consists of a pumping station with storage tank, which can be combined with the selected unit. The hydronic kit will be supplied in a pre-assembled module which must be connected to the unit through a Plug & Play system.

For two-circuit units (from 110-2-2 to 190-2-2), the HERA hydronic kit always consists of a pumping station with storage tank, but the components of the hydraulic circuit necessary for the operation of the unit it is installed on the machine, thus obtaining extremely compact dimensions.

The design and construction of these kits aim to optimize conditioning systems by managing, in the best way possible, hydronic distribution.

The units are designed and built to be installed outdoors and can be customized on the basis of the customer's specific needs. Euroklimat offers a wide choice of pump/storage tank combinations to meet all the needs of each individual system.



Plug & Play solution



Pre-assembled system



Lower installation costs

Main features:

- Base and panels made of sheet metal galvanized and painted steel, suitable for outdoor installations.
- Carbon steel closed-tank and insulated pipes with anti-condensation elastomer.
- Single or double centrifugal pump with valves of interception
- Electrical power panel with pump alternation device at each start (version with 2 pumps), reserve pump starting in case of pump failure (version with 2 pumps), protections, thermal breakers, free contacts for pumps status, degree of protection IP55.
- Closed expansion vessel.
- Safety valve.
- Air vent valve.
- Pressure gauge.
- Flow switch
- Loading / unloading valves.

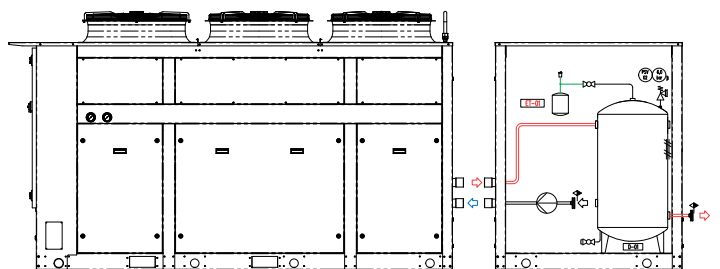

HERA

Plug & Play solution | Hydronic Kit



Carbon steel closed-tank

Centrifugal water pump

The figure is indicative only and does not represent the physical realization of the hydronic kit.

EK ref. CODE	Hydronic Kit	035-1-1 PE	055-1-1 PE	065-1-1 PE	080-1-1 PE	095-1-1 PE	110-2-2 PE	130-2-2 PE	160-2-2 PE	190-2-2 PE
IP/**/**	Integrata LP 1-0 00	o	o	o	o	o	o	o	o	o
IP/**/**	Integrata LP 1-1 00	o	o	o	o	o	o	o	o	o
IP/**/**	Integrata MP 1-0 00	o	o	o	o	o	o	o	o	o
IP/**/**	Integrata MP 1-1 00	o	o	o	o	o	o	o	o	o
IP/**/**	Integrata LP 1-0 I	o	o	o	o	o	o	o	o	o
IP/**/**	Integrata LP 1-1 I	o	o	o	o	o	o	o	o	o
IP/**/**	Integrata MP 1-0 I	o	o	o	o	o	o	o	o	o
IP/**/**	Integrata MP 1-1 I	o	o	o	o	o	o	o	o	o
BP/**/**	Base-P LP 1-0 00	-	-	-	-	-	o	o	o	o
BP/**/**	Base-P LP 1-1 00	-	-	-	-	-	o	o	o	o
BP/**/**	Base-P MP 1-0 00	-	-	-	-	-	o	o	o	o
BP/**/**	Base-P MP 1-1 00	-	-	-	-	-	o	o	o	o
BP/**/**	Base-P LP 1-0 I	-	-	-	-	-	o	o	o	o
BP/**/**	Base-P LP 1-1 I	-	-	-	-	-	o	o	o	o
BP/**/**	Base-P MP 1-0 I	-	-	-	-	-	o	o	o	o
BP/**/**	Base-P MP 1-1 I	-	-	-	-	-	o	o	o	o
BP/**/**	Base-T	o	o	o	o	o	o	o	o	o

Identificazione SOLUZIONI Kit Idronico	
BASE-P	BASE solution with electrical pump
BASE-T	BASE solution with tank
INTEGRATA	INTEGRATA solution with electrical pump and tank
MP	Medium pressure head ~ 300kPa
LP	Low pressure head ~ 150kPa
N1-N2	Num. of operating pumps - Num. of stand-by pumps
00	On-Off control
I	VFD control

o	optional	-	not available
---	----------	---	---------------

Pump manufacturers we work with:



Standard equipment



On demand

HERA

Acoustic configurations

LN - Low Noise



It represents a good compromise between price and performance in terms of reducing noise levels.



Painted galvanized sheet panels, insulated with polyurethane foam sheets, polyester based, anthracite colour, self-extinguishing non dripping.

SL - Super Low Noise



This configuration is ideal for all applications where the noise of the machine is an essential aspect.

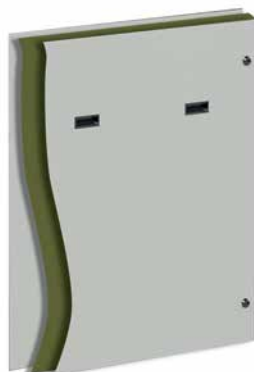

Sandwich soundproofing galvanized sheet panels, painted outside and isolated with high-density rock wool (100 Kg/m³)

XL - Extra Low Noise



This configuration allows to obtain extreme sound level reductions through the use of latest generation bionic blade fans.

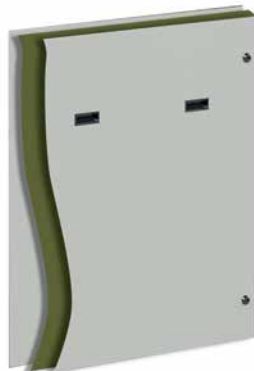

Sandwich soundproofing galvanized sheet panels, painted outside and isolated with high-density rock wool (100 Kg/m³)

HERA

Sound levels

Sound levels are obtained by means of theoretical calculations that could deviate from the real conditions of the place of installation of the unit.

Sound Power: this is the acoustic emission of the unit when operating. It is dependent on operating conditions.

Sound Pressure: this is the measurement of the effect of the acoustic emission generated by the unit at a certain distance and in the acoustic environment (reflection, absorption, directivity) in which it operates. The value will depend on the sound power of the unit, the directivity of the source and the reflectivity of the surroundings. The sound pressure level (average value) is calculated considering the unit as a point source with hemispherical type emission (non-binding value obtained from the sound power level).

It is assumed that sound power and sound pressure are linked together by defining the space and conditions as follows:

- the source is omnidirectional, i.e. the acoustic emission is the same in all directions;
- hemispherical field conditions with the presence of the support plane considered perfectly reflective.

The power is therefore distributed over an imaginary hemisphere around the unit and the following relationship applies:

- sound pressure at 1 m = sound power - 8 dBA.



HERA

Applications in extreme climate conditions (down to -20°C)

Designed for heat pump operation

SLOPING HEAT EXCHANGER



The finned pack exchanger is positioned vertically with a particular inclination that optimizes the distribution of air and the flow of condensate during defrosting.

CO- CURRENT FLOW + EEV

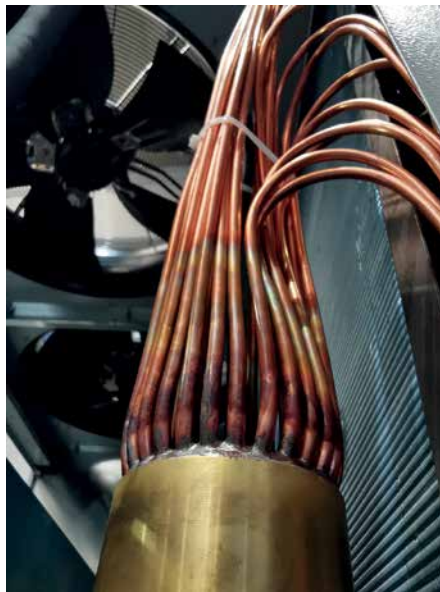

To improve efficiency, the circuit is made with a double electronic expansion valve and with the circuit with the evaporator in co-current in heating mode.

HYDROPHILIC FINNS



Increased wettability of the heat exchanger, aluminium plates which have a special coating with a hydrophilic layer, ensuring rapid removal of condensate while providing a more efficient operation of the exchanger.

Condensate drain pain

When designing the HERA range, particular attention was paid to the condensate drain pain which is positioned in oblique. In combination with the generously sized drain connections, it allows an optimal condensate evacuation during the defrosting.

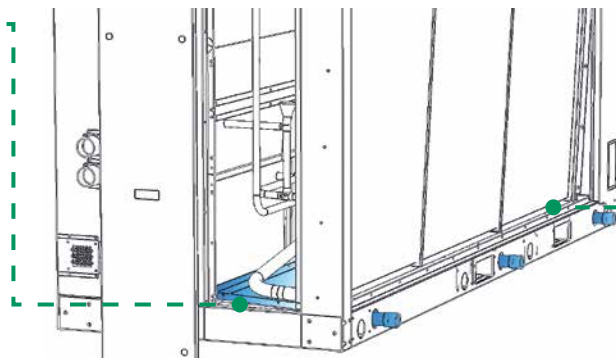

Heating cable

To avoid freezing of the water that may be deposited in the drain pain or in the condensate discharge connections, HERA heat pump is equipped with self-regulating heating cables that automatically adjust their power output to compensate for temperature changes.



HERA

Applications in extreme climate conditions (down to -20°C)

Considerations for Adverse Weather

To ensure the best performance of the HERA heat pump, performance and correct defrost in snowy, cold or high winter humidity areas, some factors should be well-thought-out in the project.

Canopy

The canopy protects the finned heat exchanger from prevailing winds, heavy snowfall and particularly violent atmospheric phenomena, without compromising the good operation of the unit. The canopy is available in galvanized sheet, painted galvanized sheet or stainless steel.

Fan Duct

The special ducts are designed to prevent the deposit of snow and ice on the fan grills, without penalizing the performance of the unit. Kits are available in galvanized sheet, painted galvanized sheet or stainless steel.

Support Frame

In the case of particularly heavy installations and with important snow accumulations, the support frame is the ideal solution because it is built to properly support the weight of the unit. The frame is available in galvanized sheet, painted galvanized sheet or stainless steel.

Electric Panel Heater

To prevent condensation and to keep a minimum temperature inside the electrical panel enclosure, an electric heater is installed. For temperature control, all the units are fitted with a thermostat.



HERA

Dimensions and Operating spaces

Frame 1 | HERA 035-1-1 PE

Overall dimensions		
D	mm	1.050
L	mm	1.750
H	mm	1.900



Frame 2 | HERA 055-1-1 PE ↔ 065-1-1 PE

Overall dimensions		
D	mm	1.050
L	mm	2.400
H	mm	1.900

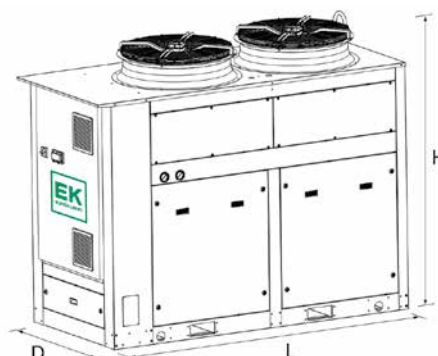

Frame 3 | HERA 080-1-1 PE ↔ 095-1-1 PE

Overall dimensions		
D	mm	1.050
L	mm	3.200
H	mm	1.900



HERA

Dimensions and Operating spaces

Frame 4 | HERA 110-2-2 PE ↔ 130-2-2 PE

Overall dimensions		
D	mm	2.100
L	mm	3.190
H	mm	1.900

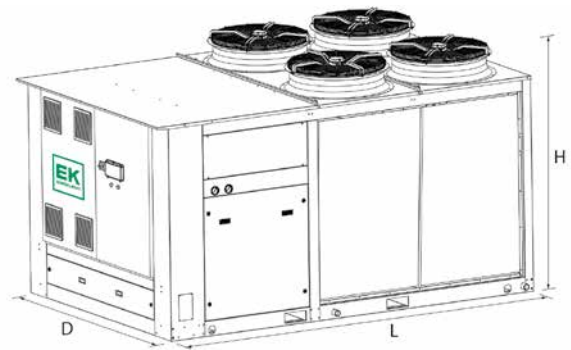

Frame 5 | HERA 160-2-2 PE ↔ 190-2-2 PE

Overall dimensions		
D	mm	2.100
L	mm	4.090
H	mm	1.900

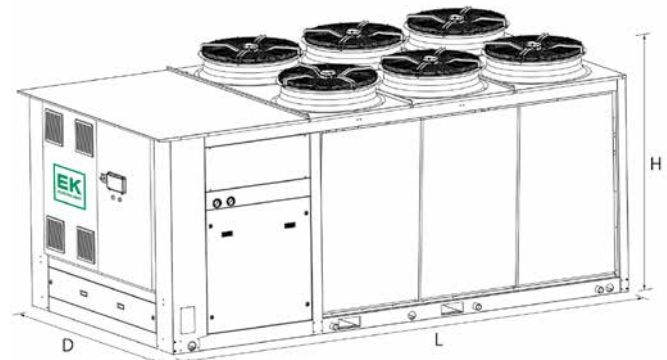

Frame 1, 2, 3

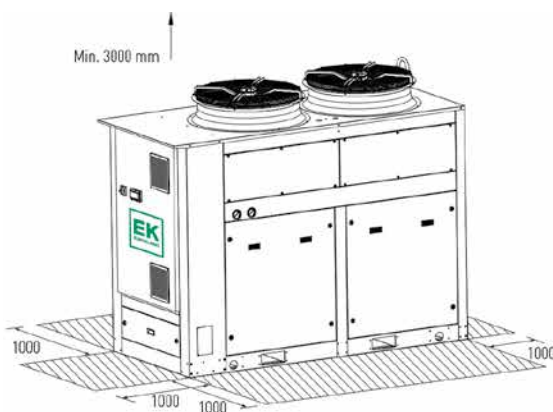

Frame 4, 5

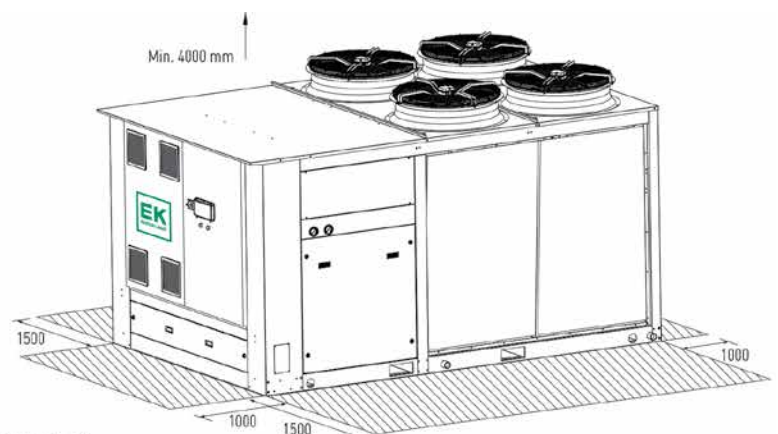

▨ Minimum operating space [mm]

HERA

Euroklimat firmly believes that Customer Satisfaction is an indispensable factor for success. A priority objective to achieve this result is the constant improvement of our products, services and the relative production processes.

For this reason, we work every day to create reliable products that can help our customers in their business.

To achieve this goal, for every single unit we produce there is a lot of work. Therefore, we are pleased to tell you how Euroklimat's HERA heat pumps are made.

1 Products design and development



Starting from market's needs we draft a concept which is then transformed into a product. The design involves many people of the company and results in the production of all the necessary documentation such as installation and operating manual, P&ID diagrams, wiring diagrams, 3D drawings and much more.

2 Supply chain



The materials procurement process is the result of a constant partnership with all our suppliers and a careful management of the timing. To do this we use modern manufacturing techniques such as MRP (Material Requirements Planning), trend analysis, which are some of the tools that feed the issuance of orders. Euroklimat's supply chain ends with the reception of the materials and their quality check.

3 Mechanical assembly



The production of the units starts at the mechanical assembly station. Here the structures are assembled and the main components such as compressors and heat exchangers are positioned and fixed.

4 Water circuit



Then the production continues at the water circuit assembly station where all the components of this circuit are mounted.

How it is made

The whole production cycle is subjected to Euroklimat's Quality Management System, that complies with the international standard UNI EN ISO 9001:2015, ensuring quality and long-term reliability.

5

Refrigerant circuit



The next stop is at refrigerant circuit assembly station. Here the pipes of the circuit are assembled and brazed welded, which will connect the various elements of the unit, such as compressor(s), condenser(s), evaporator(s), etc. The refrigerant circuit is specifically designed in order to minimize load losses and to avoid capacity reduction. The circuit is entirely made of copper tube brazed with silver alloy and it is isolated on the suction part, in order to avoid condensation.

6

Electrical wiring



Once completed the refrigeration and water circuit, we perform the electrical wiring and the connection between electric board and compressor, fan, pump, etc. Each unit is equipped with electric panel, built, wired and fully tested at the factory. Wiring numeration and optimized layout facilitate troubleshooting. The installed components are identified by nameplates to better identify the application and the type of action.

7

Running test area



The production cycle draws to a close at the running test station. Here all models are individually tested in order to check correct operation, refrigerant charge and settings of microprocessor.

Once all the checks and inspections are completed and successfully passed, the units are disconnected from the testing station and moved to the last station: the shipping area.

8

Final inspection and packaging area



The last phase of the production cycle concerns the finishing of the units and the packaging for shipping. Here all the units are subjected to a final check and prepared for the shipping. If a special packaging has not been requested the standard one is realized with heat-shrinkable plastic film that cover the whole unit and protect it from dust, water and other atmospheric agents. Polystyrol corners are also foreseen in order to protect the unit from potential damages caused during transports. The units are then ready for transportation and final installation.

HERA

Transport of the unit with R290 charge

The units are normally supplied with the R290 gas charge.

HERA Heat Pumps have United Nations number designation UN 3358.



Observance to national and international regulations is necessary if refrigeration equipment containing a charge of HC refrigerant is to be transported. Particular requirements are generally determined by the equipment charge size. In general, the applicable regulations require adequate packaging and marking.

Transport companies should also be consulted when transporting equipment containing HC refrigerants.

Transport by road



Transport by road and rail within Europe is covered by the Articles Dangereuses par Routier, 2009 (ADR).

Equipment containing less than 12 kg of flammable refrigerant is exempt from regulations for carriage provided it is protected by design (i.e. conforms to the appropriate safety standards). Where the charge is above 12 kg, the equipment is subject to the provisions for any receptacle containing flammable gases.

HERA 035-1-1 PE
HERA 055-1-1 PE
HERA 065-1-1 PE
HERA 080-1-1 PE
HERA 095-1-1 PE
HERA 110-2-2 PE
HERA 130-2-2 PE



HERA 160-2-2 PE
HERA 190-2-2 PE



Transport by sea



The International Maritime Dangerous Goods Code, 2008 (IMDG) prescribes requirements for transport of equipment by sea.

Refrigerating machines containing less than 100g of flammable refrigerant are not subject to the regulations. Otherwise packaging requires special marking. Refrigerating machines may be carried unpacked in crates or other appropriate over-packs, provided that the equipment has been pressure tested and designed so as to prevent the release of refrigerant during transport conditions. However, if the charge is less than 12 kg then these requirements do not apply.

HERA 035-1-1 PE
HERA 055-1-1 PE
HERA 065-1-1 PE
HERA 080-1-1 PE
HERA 095-1-1 PE
HERA 110-2-2 PE
HERA 130-2-2 PE



HERA 160-2-2 PE
HERA 190-2-2 PE



Transport by air



The International Civil Aviation Organisation/ International Air Transport Association, 2009 (IATA) prescribes the regulations for transport by air.

This forbids transport of equipment containing more than 0.1 kg in either passenger or cargo planes. If transport by air is necessary, the regulations do permit up to 150 kg of flammable refrigerant to be carried by cylinder, so systems can be charged on-site.

HERA 035-1-1 PE
HERA 055-1-1 PE
HERA 065-1-1 PE
HERA 080-1-1 PE
HERA 095-1-1 PE
HERA 110-2-2 PE
HERA 130-2-2 PE
HERA 160-2-2 PE
HERA 190-2-2 PE

NITROGEN CHARGE ONLY

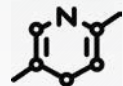

On request they can be supplied with a nitrogen preload, normally at a pressure between 1 and 2 bar. In this case the installer must take charge of the vacuum and circuit loading operations according to the indications provided in the use and maintenance manual.



HERA

Standard and optional packing

The standard packing foreseen for HERA range consists of heat-shrinkable plastic film that cover the whole unit and protect it from dust, water and other atmospheric agents. Polystyrol corner are also foreseen in order to protect the unit from potential damages caused during transports.

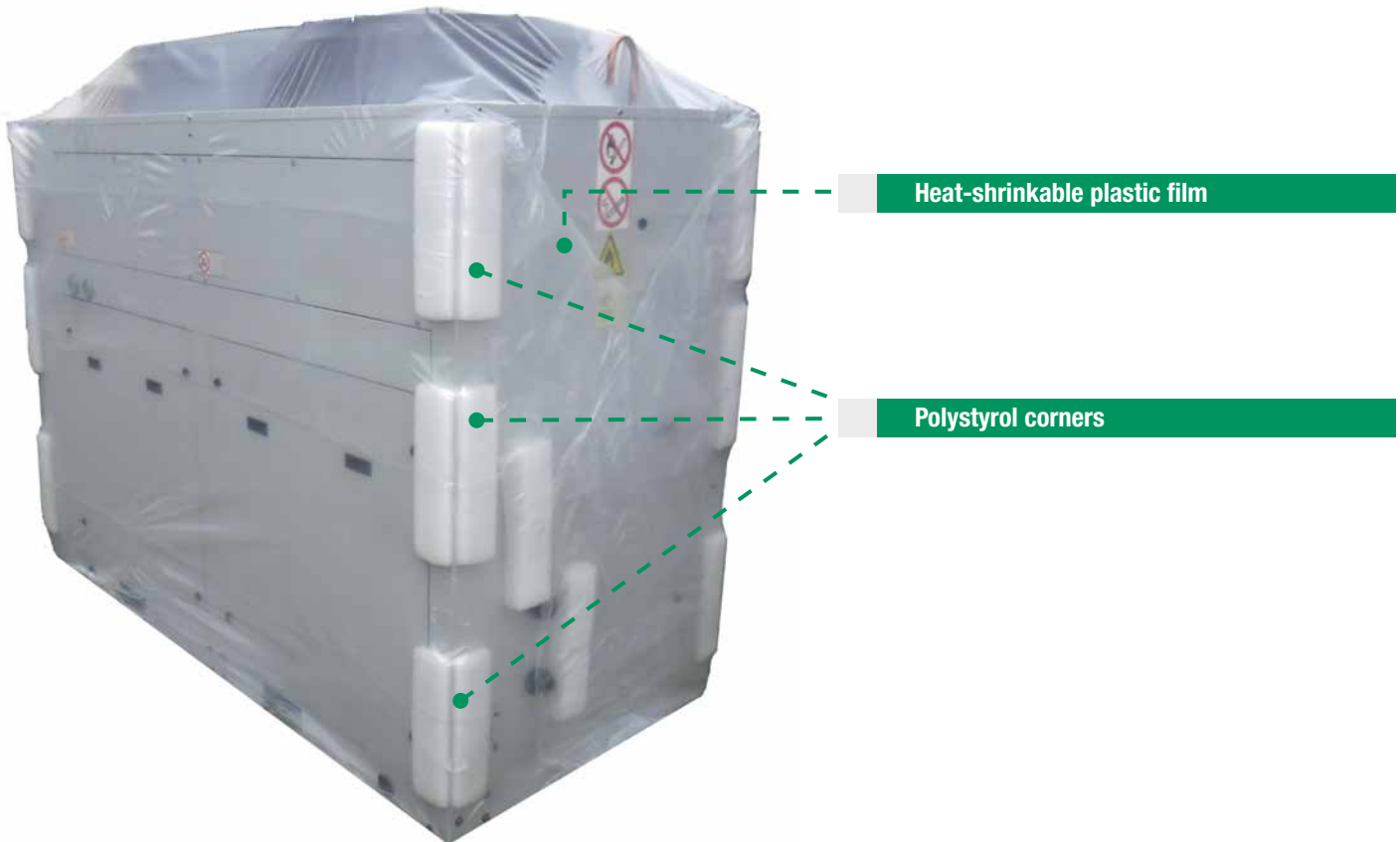

EK ref. CODE	HERA	035-1-1 PE	055-1-1 PE ↔ 065-1-1 PE	080-1-1 PE ↔ 095-1-1 PE	110-2-2 PE ↔ 130-2-2 PE	160-2-2 PE ↔ 190-2-2 PE
	Transport and packaging					
3517-030	Packaging with wooden cage without base (non-fumigated wood)	○	○	○	-	-
3517-036	Standard packaging (heat-shrinkable plastic film)	●	●	●	●	●
3517-037	Standard packaging with wooden base	○	○	○	-	-

●	<i>standard equipment</i>	○	<i>optional</i>	-	<i>not available</i>
---	---------------------------	---	-----------------	---	----------------------

WebService²

What do I receive with my order?

When you order an Euroklimat product, after the order confirmation, you get your user ID and password to access to WebService².

With the advent of information technology, there are several possibilities for communication and transmission of information in real-time.

Euroklimat wanted to exploit these instruments creating a website, which provides an important support to all customers: WebService².



WebService² - web portal 24/7

The simple and intuitive interface of the site allows you to “browse” quickly and easily reach the information you need. Planned and designed for the specific competences, “webservice” is a web portal that enables customers or support centres to access the detailed documentation for each single machine:

- » order confirmation, waybill and invoice
- » declaration of conformity
- » operating and maintenance manual
- » electric diagram
- » construction drawing
- » complete list of spare parts
- » ... and much much more.

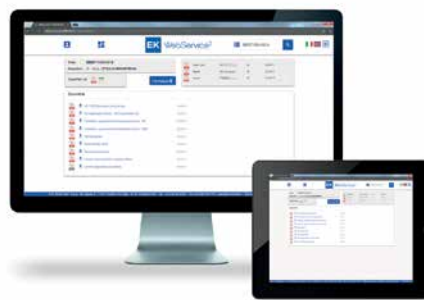

WebService²



The information is consequently always available and up-to-date, also when you are physically at the site of installation.

Thanks to the new features of WebService², it is now possible to check in real time the availability of spare parts for each serial number, simply by accessing the service with your own web credentials.

The “mission” of Euroklimat is always to improve the service offered to customers.



R290 References

Customers who have chosen us



Nestlé



Metro



Roche Diagnostic



Coop



Waitrose



Danish Technological Institute



E.ON Kernkraft



Carrefour



Del Monte Foods



John Lewis Birmingham



Cityringen Copenhagen



The Coca Cola Company

Some R290 Installations



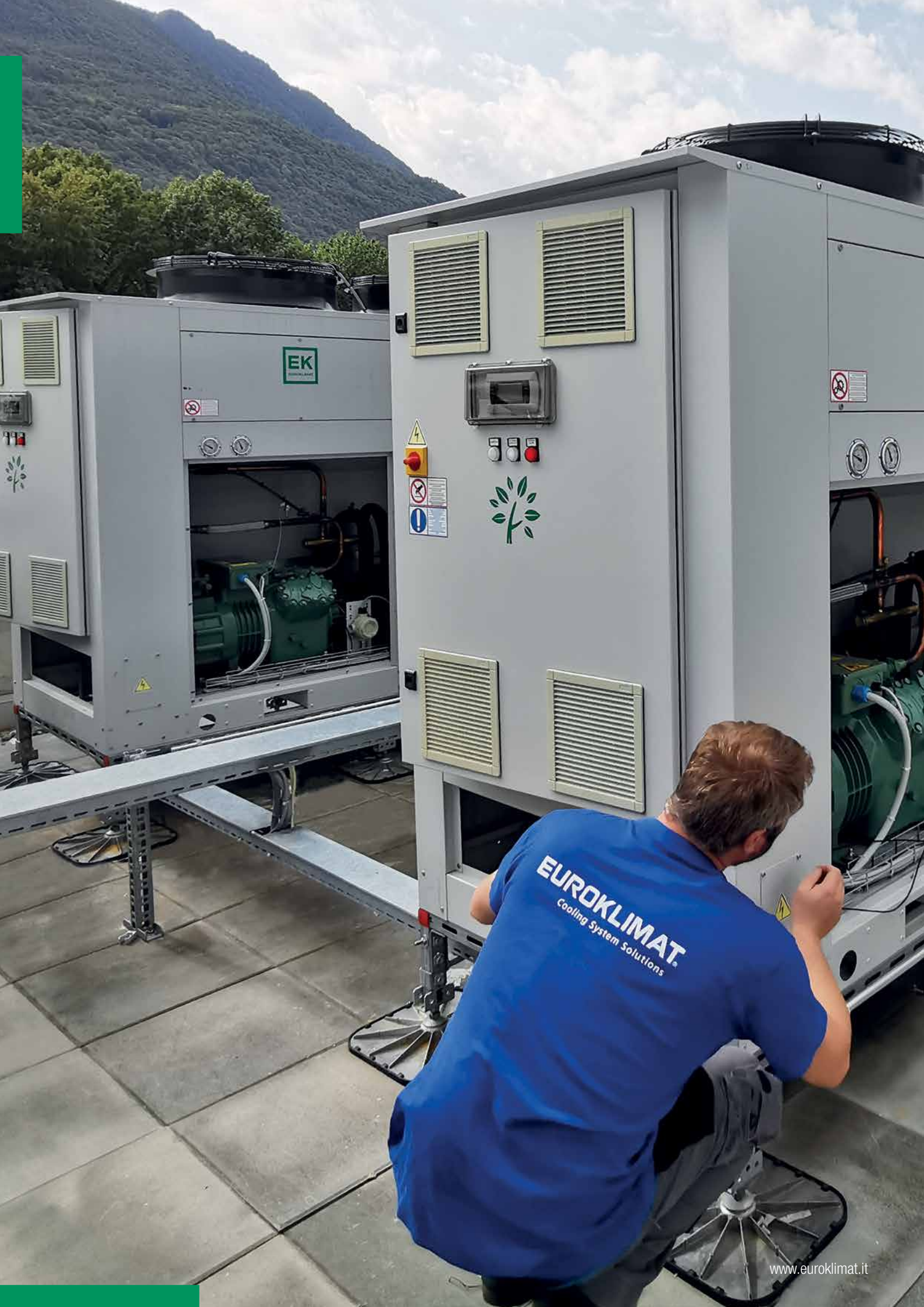

EK

EUROKLIMAT
Cooling System Solutions

Our plants and quality management



Over 50 years of business

Since we set up business in 1963, the company's head offices have always been in Italy, near Milan. Today, our aim is to be a market leader in chillers with natural refrigerant (propane): by doing this, we are helping the industry to become more efficient, preserving natural resources and protecting the environment.

Organization in Italy

At our Italian plant spread over an area of 6,000 square metres, with a work force of 60 people, Euroklimat designs and produces refrigeration units, heat pumps and precision air conditioners that can be used both in industrial processes and traditional comfort applications.

Infinite quality

Euroklimat firmly believes that Customer Satisfaction is an indispensable factor for success. A priority objective to achieve this result is the constant improvement of our products, services and the relative production processes.

This objective means involving all of the company's resources with planned, systematic activities for Quality; for this reason, our system complies with the international standard UNI EN ISO 9001:2015.

Organization in China

Our plant covers a surface of approximately 100,000 square metres, with over 1,000 people and includes a large test chamber and a sophisticated R&D laboratory, in addition to real production departments, where the performance of the units is measured before being placed on the market.



**COMPANY
WITH QUALITY SYSTEM
CERTIFIED BY DNV GL
= ISO 9001 =**



Factory Italy • Sizzano



Factory China • Huangjiang, Dongguan, Guangdong

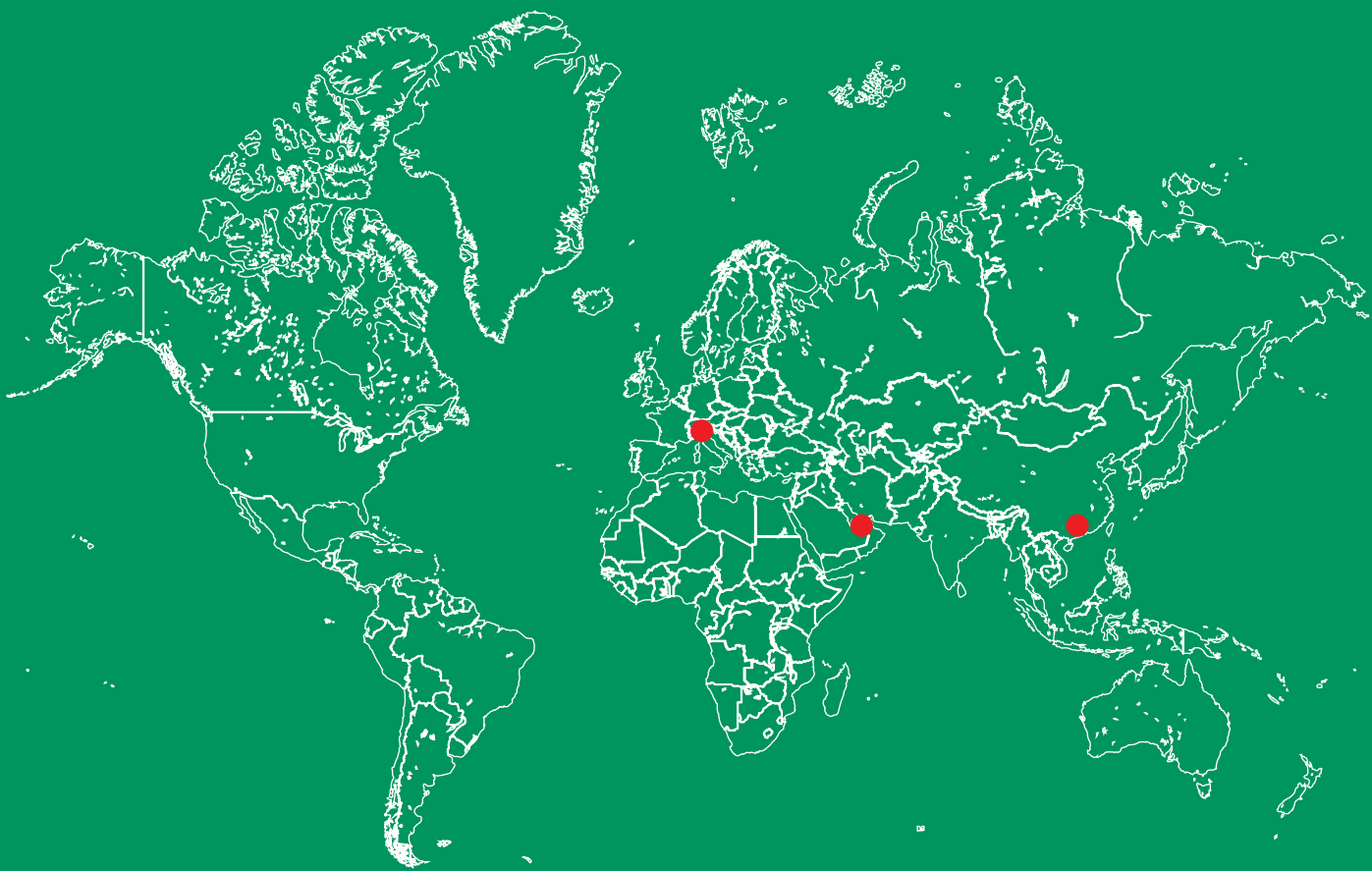

The data are indicative and not binding. Euroklimat reserves the right to make changes at any time without notice



EUROKLIMAT®
Cooling System Solutions

EUROKLIMAT SpA

Factory Italy

Via Liguria, 8
27010 Siziano (PV) Italy

T: +39 038 2610282
E: info@euroklimat.it

www.euroklimat.it



Euroklimat Co., Ltd

Factory China

Euroklimat Industrial Park,
Huangjiang, Dongguan, Guangdong, China

T +86 0769 8366 0888 ext. 8260
E: info@euroklimat.it

www.euroklimat.com.cn

EUROKLIMAT FZCO

Office Dubai

High Bay Office 24, Dubai Silicon Oasis,UAE
PO Box 28178, Dubai, UAE

T + 971 4 3423152
E: info@ek-me.com

www.euroklimatme.com



99992064 CATALOGO PDC "HERA" "HERA_08_23_rev3_ENG"